

**LOCKS FOR WOODEN FRAMES .34**



E N G L I S H

**Dear Customer,**

the outcome of a recent survey has stood out a customer satisfaction level of 92,8%. This trustworthy and positive result is the effect of the commitment of all the collaborators and employees, which we aim to maintain and improve. It is the successful completion of the targets defined by the company management, which are included in the "Group Mission" too:  
"To develop, manufacture and offer door locking systems, integrating security, user-friendliness, compliance with standards and technical specifications drawn up by designers and installers. To provide our distribution network with the necessary technical and sales support."

- Our mission translate into the following values within the System:
- The respect of our world: Ethics, Environment, Safety, Quality, and Privacy;
  - Product reliability;
  - Endless innovation;
  - Respecting our partners' and customers' interests.

The fulfillment of these values allows to improve and implement our Integrated Management System, whose strategic aim and daily effort is the achievement of the following System Certifications and all the necessary product certifications by all the companies of ISEO Group.



**Quality Management System**



**Enviromental Management System**



**Occupational Health and Safety Management System**

TSEO  
MADE IN ITALY

ORIGINAL  
TSEO  
MADE IN ITALY



**Locks for  
wooden  
frames**



|  |             |  |             |
|--|-------------|--|-------------|
| <b>Infilare 291</b><br>e.g. code 2911*-2912*                   | <b>3-5</b>  | <b>Furniture locks</b>                 | <b>3-26</b> |
|  |             | e.g. code 100*-102*-106*-107*          |             |
| <b>Infilare 200N</b><br>e.g. code 200N*-210N*-280N*            | <b>3-9</b>  | <b>Mortice locks</b>                   | <b>3-31</b> |
|  |             | e.g. code 1301*-1321*                  |             |
| <b>2001</b><br>e.g. code 5210*-5211*-5213*-5310*-5312*         | <b>3-15</b> | <b>Mortice locks<br/>with cylinder</b> | <b>3-35</b> |
|  |             | e.g. code 463*-316*                    |             |
| <b>Elettrica 500</b><br>e.g. code 5115*-5116*-5117*-5118*      | <b>3-18</b> | <b>Sbarra</b>                          | <b>3-38</b> |
|  |             | e.g. code 904*                         |             |
| <b>Portoncino</b><br>e.g. code 401*-411*-421*-431*             | <b>3-19</b> | <b>Perfecta</b>                        | <b>3-41</b> |
|  |             | e.g. code 911*-913*-915*               |             |
| <b>Ferroglietto</b><br>e.g. code 300*-310*-320*-330*-340*-350* | <b>3-23</b> | <b>Vis</b>                             | <b>3-47</b> |
|  |             | e.g. code 9102*-9103*-9104*            |             |
| <b>Verrou</b><br>e.g. code 460*-470*                           | <b>3-25</b> |  |             |

**Locks for  
wooden  
frames**

**Infilare 291**



## Infilare 291



The mortice lock series 291 has obtained the product certification **038BE/1** (except for the version with roller and deadbolt only) and the certificate of conformity **CE 2193**. It is available in different finishings and locking versions. In conjunction with ISEO cylinders it provides high security to the doors.

### Main features:

- steel closed lockcase on all sides: this prevents profile machining chips from entering the mechanism;
- two throws standard deadbolt or two throws anti-break and anti-saw deadbolt;
- reversible latchbolt or roller;
- center distance mm 85;
- 6 fixing holes for escutcheon and security plates;
- front plate rounded or squared mm 22, in: 24 KT gold plated brass, polished and painted brass, chrome-plated and polished brass, nickel-plated satin brass, bronze-plated and brushes brass;
- front plate rounded or squared mm 24, in stainless steel;
- operating with European profile cylinder.



All the updated certificates can be downloaded from our web site:  
[www.iseoserrature.it](http://www.iseoserrature.it)

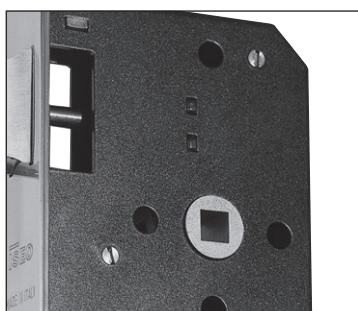

Closed lockcase and fixing holes

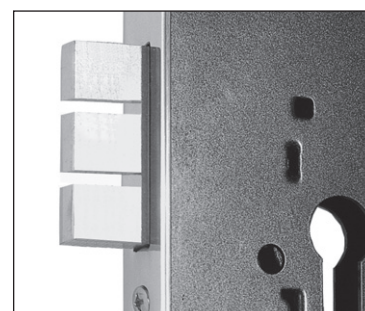

Anti-drill and anti-saw deadbolt





## Infilare 291

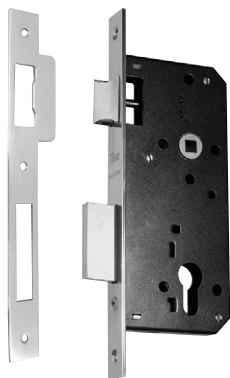

Cylinder to be ordered separately

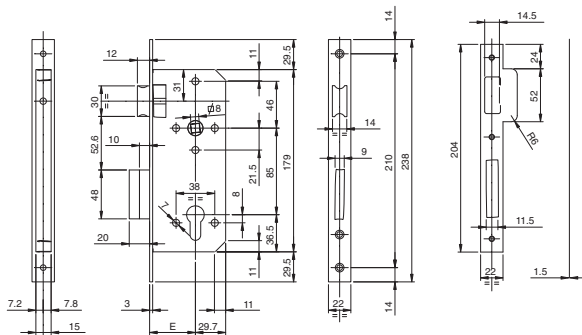

**CLOSED-CASE** mortice lock operating with European profile cylinder.  
 Two mm 10 throws. Reversible latchbolt. Handle follower mm 8.  
 Center distance mm 85. 6 fixing holes for escutcheons and security plates.  
 Striking plate. Fixing screws.

Code: **2911 X 5 XX X**  
 Front plate Backset Finishes

Front plate mm 22 = 0  
 Front plate mm 24 (only for INOX front plate) = 4

Backset= mm **40**

|   |      |           |
|---|------|-----------|
| Front plate 24 KT GOLD PLATED brass, 22 mm square edge                                      | = A  | <b>45</b> |
| Front plate polished and painted brass, 22 mm square edge                                   | = L  | <b>50</b> |
| Front plate chrome-plated and polished brass, 22 mm square edge                             | = K  | <b>55</b> |
| Front plate nickel-plated satin brass, 22 mm square edge                                    | = N  | <b>60</b> |
| Front plate bronze-plated and brushed brass, 22 mm square edge                              | = B  | <b>70</b> |
| Front plate stainless steel, 22/24 mm square edge   | = 2  |           |
| Front plate stainless steel, 22/24 mm square edge, packed in nylon bags with 25 pieces each | = 2N |           |

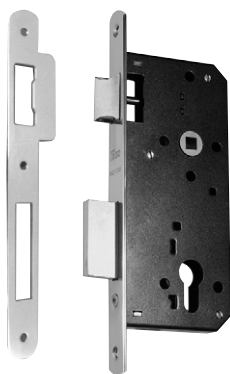

Cylinder to be ordered separately

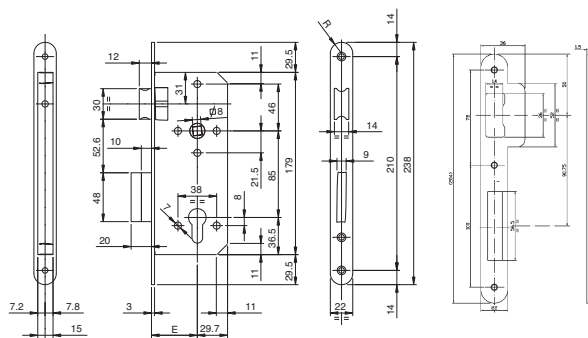

**CLOSED-CASE** mortice lock operating with European profile cylinder.  
 Two mm 10 throws. Reversible latchbolt. Handle follower mm 8.  
 Center distance mm 85. 6 fixing holes for escutcheons and security plates.  
 Striking plate. Fixing screws.

Code: **2911 15 XX X**  
 Backset Finishes

|   |      |           |
|---|------|-----------|
| Front plate 24 KT GOLD PLATED brass, 22 mm round edge                                   | = A  | <b>40</b> |
| Front plate polished and painted brass, 22 mm round edge                                | = L  | <b>45</b> |
| Front plate chrome-plated and polished brass, 22 mm round edge                          | = K  | <b>50</b> |
| Front plate nickel-plated satin brass, 22 mm round edge                                 | = N  | <b>55</b> |
| Front plate bronze-plated and brushed brass, 22 mm round edge                           | = B  | <b>60</b> |
| Front plate stainless steel, 22 mm round edge   | = 2  | <b>70</b> |
| Front plate stainless steel, 22 mm round edge, packed in nylon bags with 25 pieces each | = 2N |           |

Backset= mm **40**

**REQUESTS FOR ANY FINISHES OR BACKSETS WILL BE ANALYZED DEPENDING ON THE QUANTITY REQUESTED.**





## Infilare 291

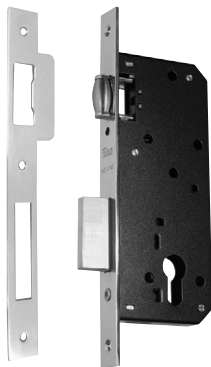

Cylinder to be ordered separately

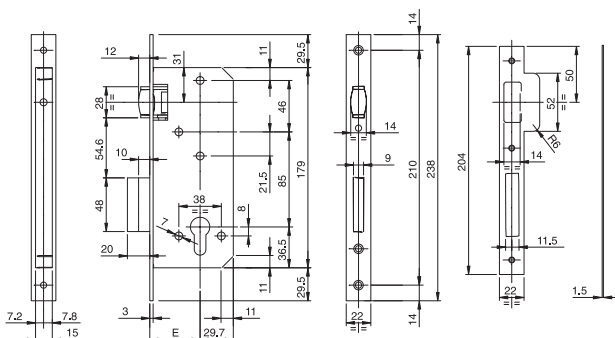

**CLOSED-CASE** mortice lock operating with European profile cylinder.  
Two mm 10 throws. Adjustable roller.  
6 fixing holes for escutcheons and security plates.  
Striking plate. Fixing screws.

Code: **2912 05 XX X**

Backset= mm **40**  
**45**  
**50**  
**55**  
**60**  
**70**

- Front plate 24 KT GOLD PLATED brass, 22 mm square edge = **A**
- Front plate polished and painted brass, 22 mm square edge = **L**
- Front plate chrome-plated and polished brass, 22 mm square edge = **K**
- Front plate nickel-plated satin brass, 22 mm square edge = **N**
- Front plate bronze-plated and brushed brass, 22 mm square edge = **B**



Cylinder to be ordered separately

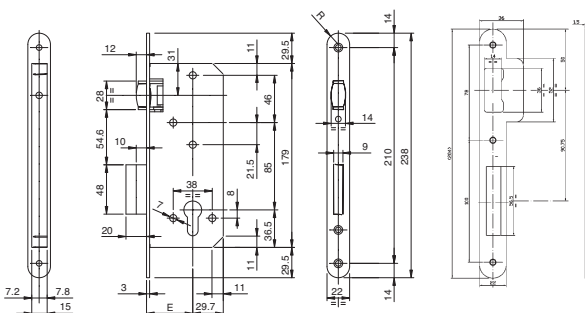

**CLOSED-CASE** mortice lock operating with European profile cylinder.  
Two mm 10 throws.  
Adjustable roller. 6 fixing holes for escutcheons and security plates.  
Striking plate. Fixing screws.

Code: **2912 15 XX X**

Backset= mm **40**  
**45**  
**50**  
**55**  
**60**  
**70**

- Front plate 24 KT GOLD PLATED brass, 22 mm round edge = **A**
- Front plate polished and painted brass, 22 mm round edge = **L**
- Front plate chrome-plated and polished brass, 22 mm round edge = **K**
- Front plate nickel-plated satin brass, 22 mm round edge = **N**
- Front plate bronze-plated and brushed brass, 22 mm round edge = **B**

**REQUESTS FOR ANY FINISHES OR BACKSETS WILL BE ANALYZED DEPENDING ON THE QUANTITY REQUESTED.**



## Infilare 291

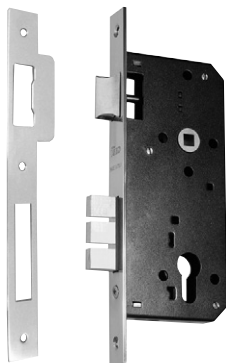

Cylinder to be ordered separately

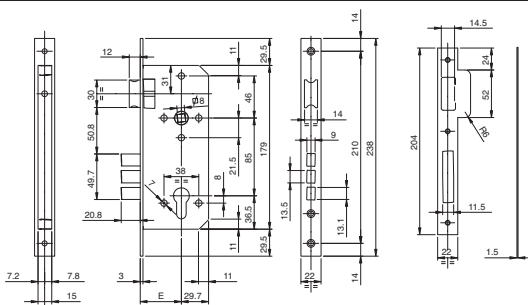

**CLOSED-CASE** mortice lock operating with European profile cylinder.

**ANTI-SAW AND ANTI-BREAK DEADBOLT.**

Two mm 10,4 throws. Reversible latchbolt. Handle follower mm 8.  
Center distance mm 85. 6 fixing holes for escutcheons and security plates.  
Striking plate. Fixing screws.

Code: **2911 25 XX X**

|   |             |
|---|-------------|
| Front plate 24 KT GOLD PLATED brass, 22 mm square edge                                      | = <b>A</b>  |
| Front plate polished and painted brass, 22 mm square edge                                   | = <b>L</b>  |
| Front plate chrome-plated and polished brass, 22 mm square edge                             | = <b>K</b>  |
| Front plate nickel-plated satin brass, 22 mm square edge                                    | = <b>N</b>  |
| Front plate bronze-plated and brushed brass, 22 mm square edge                              | = <b>B</b>  |
| Front plate stainless steel, 22 mm square edge  | = <b>2</b>  |
| Front plate stainless steel, 22 mm square edge,<br>packed in nylon bags with 25 pieces each | = <b>2N</b> |

Backset= mm **40**  
**45**  
**50**  
**55**  
**60**  
**70**

Backset  
Finishes

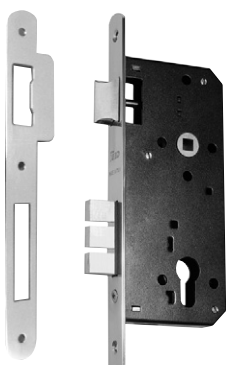

Cylinder to be ordered separately

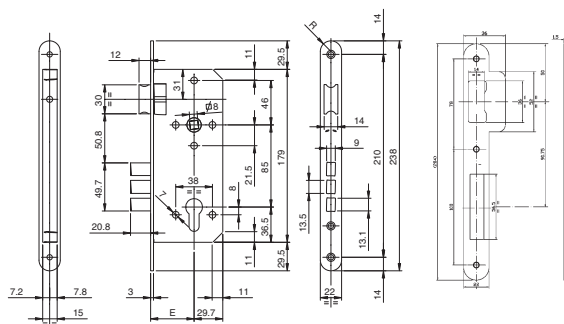

**CLOSED-CASE** mortice lock operating with European profile cylinder.

**ANTI-SAW AND ANTI-BREAK DEADBOLT.**

Two mm 10,4 throws. Reversible latchbolt. Handle follower mm 8.  
Center distance mm 85. 6 fixing holes for escutcheons and security plates.  
Striking plate. Fixing screws.

Code: **2911 35 XX X**

|  |             |
|--|-------------|
| Front plate 24 KT GOLD PLATED brass, 22 mm round edge                                      | = <b>A</b>  |
| Front plate polished and painted brass, 22 mm round edge                                   | = <b>L</b>  |
| Front plate chrome-plated and polished brass, 22 mm round edge                             | = <b>K</b>  |
| Front plate nickel-plated satin brass, 22 mm round edge                                    | = <b>N</b>  |
| Front plate bronze-plated and brushed brass, 22 mm round edge                              | = <b>B</b>  |
| Front plate stainless steel, 22 mm round edge  | = <b>2</b>  |
| Front plate stainless steel, 22 mm round edge,<br>packed in nylon bags with 25 pieces each | = <b>2N</b> |

Backset= mm **40**  
**45**  
**50**  
**55**  
**60**  
**70**

Backset  
Finishes

**REQUESTS FOR ANY FINISHES OR BACKSETS WILL BE ANALYZED DEPENDING ON THE QUANTITY REQUESTED.**

## Infilare 200N



The mortice lock series 200N has obtained the product certification **102BE/0** in compliance with the standard **UNI EN 12209:05**.

The mortice locks series 200N are available in different finishes and locking versions. In conjunction with ISEO cylinders they provide different levels of security to the doors.

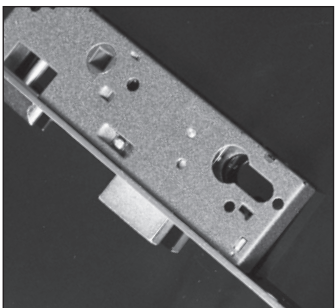

### 200N series main features:

- Painted steel lockcase closed on all sides: this prevents profile machining chips from entering the mechanism.
- 6 fixing holes for escutcheons and security plates.
- Reversible latchbolt or roller.
- Deadbolt 20 mm, 2 throws.
- Operating with European profile cylinder or double handle follower (service doors).
- Latchbolt operated by handle and key.
- Center distance mm 85.
- Handle follower mm 8.
- Backset 40, 45, 50, 60, 70 mm.
- Front plate rounded or squared mm 22.

### Front plate finishes:

- Gold-plated steel
- Brass-plated steel
- Chrome-plated steel
- Stainless steel

### 200N series main features backset 25, 30, 35:

- Painted steel lockcase closed on all sides: this prevents profile machining chips from entering the mechanism.
- Reversible latchbolt.
- Deadbolt 15 mm, 1 throws.
- 2 fixing holes 21,5 mm below and 46 mm above from the handle.
- Operating with European profile cylinder.
- Latchbolt operated by handle and key.
- Center distance mm 85.
- Handle follower mm 8.
- Backset 26, 31, 36 mm.
- Front plate rounded or squared mm 22.

### Front plate finishes:

- Brass-plated steel
- Gold-plated steel on request

Code

Multiple  
package  
Single  
package

Min. ord.

## Infilare 200N



Cylinder and striking  
plate to be ordered  
separately

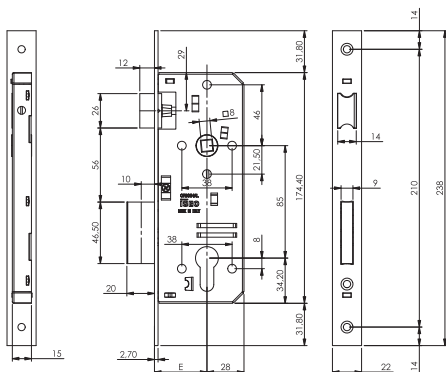

**CLOSED-CASE** mortice lock with LATCHBOLT and DEADBOLT, operating with European profile cylinder.

Two mm 10 throws. Reversible latchbolt.

Handle follower mm 8. Center distance mm 85.

6 fixing holes for escutcheons and security plates.

2 escutcheons. Fixing screws.

### BRASS-PLATED STEEL FRONT PLATE. SQUARE EDGE

|               |                |   |    |    |
|---------------|----------------|---|----|----|
| Backset mm 40 | <b>200N401</b> | 1 | 10 | 10 |
| Backset mm 45 | <b>200N451</b> | 1 | 10 | 10 |
| Backset mm 50 | <b>200N501</b> | 1 | 10 | 10 |
| Backset mm 60 | <b>200N601</b> | 1 | 10 | 10 |
| Backset mm 70 | <b>200N701</b> | 1 | 10 | 10 |

### STAINLESS STEEL FRONT PLATE. SQUARE EDGE

|               |                |   |    |    |
|---------------|----------------|---|----|----|
| Backset mm 40 | <b>200N402</b> | 1 | 10 | 10 |
| Backset mm 45 | <b>200N452</b> | 1 | 10 | 10 |
| Backset mm 50 | <b>200N502</b> | 1 | 10 | 10 |
| Backset mm 60 | <b>200N602</b> | 1 | 10 | 10 |
| Backset mm 70 | <b>200N702</b> | 1 | 10 | 10 |

### CHROME-PLATED STEEL FRONT PLATE. SQUARE EDGE

|               |                |   |    |    |
|---------------|----------------|---|----|----|
| Backset mm 40 | <b>200N403</b> | 1 | 10 | 10 |
| Backset mm 45 | <b>200N453</b> | 1 | 10 | 10 |
| Backset mm 50 | <b>200N503</b> | 1 | 10 | 10 |
| Backset mm 60 | <b>200N603</b> | 1 | 10 | 10 |
| Backset mm 70 | <b>200N703</b> | 1 | 10 | 10 |

### GOLD-PAINTED STEEL FRONT PLATE. SQUARE EDGE

|               |                |   |    |    |
|---------------|----------------|---|----|----|
| Backset mm 40 | <b>200N406</b> | 1 | 10 | 10 |
| Backset mm 45 | <b>200N456</b> | 1 | 10 | 10 |
| Backset mm 50 | <b>200N506</b> | 1 | 10 | 10 |
| Backset mm 60 | <b>200N606</b> | 1 | 10 | 10 |
| Backset mm 70 | <b>200N706</b> | 1 | 10 | 10 |

Version with cylinder on request

Code  
Multiple  
package  
Single  
package  
Min. ord.

## Infilare 200N



Cylinder and striking  
plate to be ordered  
separately

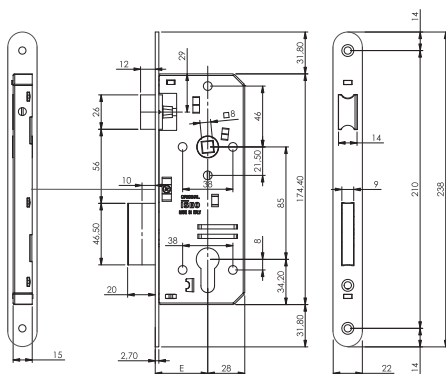

**CLOSED-CASE** mortice lock with LATCHBOLT and DEADBOLT, operating with European profile cylinder.  
Two mm 10 throws. Reversible latchbolt.  
Handle follower mm 8. Center distance mm 85.  
6 fixing holes for escutcheons and security plates.  
2 escutcheons. Fixing screws.

### BRASS-PLATED STEEL FRONT PLATE. ROUND EDGE

|               |                |   |    |    |
|---------------|----------------|---|----|----|
| Backset mm 40 | <b>210N401</b> | 1 | 10 | 10 |
| Backset mm 45 | <b>210N451</b> | 1 | 10 | 10 |
| Backset mm 50 | <b>210N501</b> | 1 | 10 | 10 |
| Backset mm 60 | <b>210N601</b> | 1 | 10 | 10 |
| Backset mm 70 | <b>210N701</b> | 1 | 10 | 10 |

### STAINLESS STEEL FRONT PLATE. ROUND EDGE

|               |                |   |    |    |
|---------------|----------------|---|----|----|
| Backset mm 40 | <b>210N402</b> | 1 | 10 | 10 |
| Backset mm 45 | <b>210N452</b> | 1 | 10 | 10 |
| Backset mm 50 | <b>210N502</b> | 1 | 10 | 10 |
| Backset mm 60 | <b>210N602</b> | 1 | 10 | 10 |
| Backset mm 70 | <b>210N702</b> | 1 | 10 | 10 |

### CHROME-PLATED STEEL FRONT PLATE. ROUND EDGE

|               |                |   |    |    |
|---------------|----------------|---|----|----|
| Backset mm 40 | <b>210N403</b> | 1 | 10 | 10 |
| Backset mm 45 | <b>210N453</b> | 1 | 10 | 10 |
| Backset mm 50 | <b>210N503</b> | 1 | 10 | 10 |
| Backset mm 60 | <b>210N603</b> | 1 | 10 | 10 |
| Backset mm 70 | <b>210N703</b> | 1 | 10 | 10 |

### GOLD-PAINTED STEEL FRONT PLATE. ROUND EDGE

|               |                |   |    |    |
|---------------|----------------|---|----|----|
| Backset mm 40 | <b>210N406</b> | 1 | 10 | 10 |
| Backset mm 45 | <b>210N456</b> | 1 | 10 | 10 |
| Backset mm 50 | <b>210N506</b> | 1 | 10 | 10 |
| Backset mm 60 | <b>210N606</b> | 1 | 10 | 10 |
| Backset mm 70 | <b>210N706</b> | 1 | 10 | 10 |

Version with cylinder on request

Code

Multiple  
package  
Single  
package

Min. ord.

## Infilare 200N



Cylinder and striking  
plate to be ordered  
separately

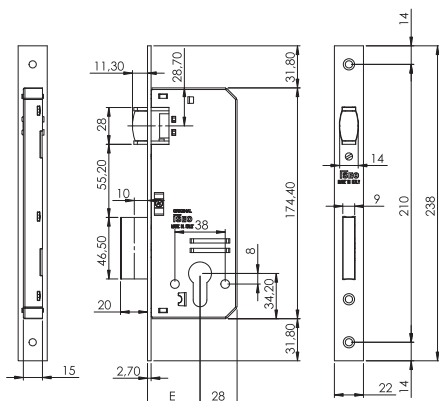

**CLOSED-CASE** mortice lock with ROLLER and DEADBOLT, operating with European profile cylinder.

**BRASS-PLATED STEEL FRONT PLATE. SQUARE EDGE.**

Two mm 10 throws. 6 fixing holes for escutcheons and security plates.

Adjustable roller. 2 escutcheons. Fixing screws.

|               |                |   |    |    |
|---------------|----------------|---|----|----|
| Backset mm 40 | <b>280N401</b> | 1 | 10 | 10 |
| Backset mm 45 | <b>280N451</b> | 1 | 10 | 10 |
| Backset mm 50 | <b>280N501</b> | 1 | 10 | 10 |

### Version with cylinder on request



Striking plate to be  
ordered separately

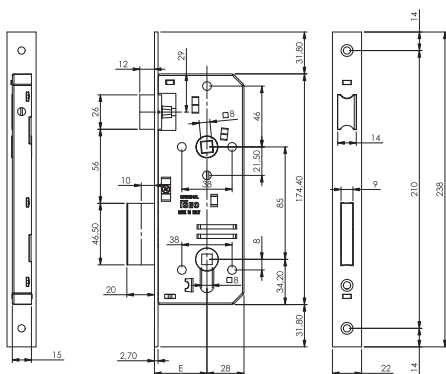

**CLOSED-CASE** mortice lock with LATCHBOLT and DEADBOLT, operating with

DOUBLE HANDLE FOLLOWER 8 mm for locked and unlocked function.

**BRASS-PLATED STEEL FRONT PLATE. SQUARE EDGE.**

Two mm 10 throws. 6 fixing holes for escutcheons and security plates.

Reversible latchbolt. 2 escutcheons. Fixing screws.

|               |                |   |    |    |
|---------------|----------------|---|----|----|
| Backset mm 40 | <b>221N401</b> | 1 | 10 | 10 |
| Backset mm 45 | <b>221N451</b> | 1 | 10 | 10 |
| Backset mm 50 | <b>221N501</b> | 1 | 10 | 10 |

Code  
Multiple  
package  
Single  
package  
Min. ord.

**Infilare 200N**



Cylinder and striking  
plate to be ordered  
separately

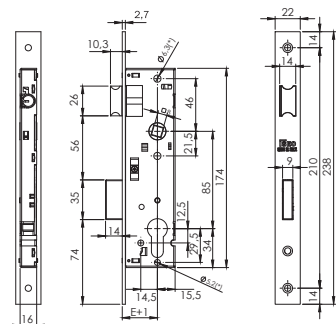

**CLOSED-CASE** mortice lock with latchbolt and deadbolt, operating with European profile cylinder.

**BRASS-PLATED STEEL FRONT PLATE** with **SQUARE EDGE**. One mm 15 throws.

Reversible latchbolt. Latchlocking by key or HANDLE.

Center distance 85 mm. Handle follower mm 8. 2 escutcheons. Fixing screws.

|               |                |   |    |    |
|---------------|----------------|---|----|----|
| Backset mm 26 | <b>200N251</b> | 1 | 10 | 10 |
| Backset mm 31 | <b>200N301</b> | 1 | 10 | 10 |
| Backset mm 36 | <b>200N351</b> | 1 | 10 | 10 |

Version with cylinder or gold-painted finish on request



Cylinder and striking  
plate to be ordered  
separately

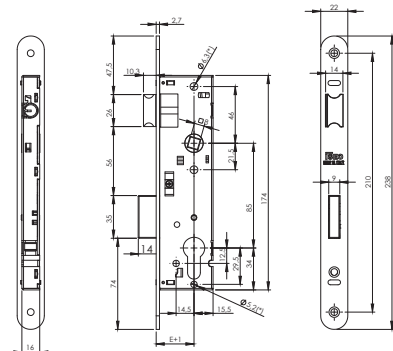

**CLOSED-CASE** mortice lock with latchbolt and deadbolt, operating with European profile cylinder.

**BRASS-PLATED STEEL FRONT PLATE** with **ROUND EDGE**. One mm 15 throws.

Reversible latchbolt. Latchlocking by key or HANDLE.

Center distance 85 mm. Handle follower mm 8. 2 escutcheons. Fixing screws.

|               |                |   |    |    |
|---------------|----------------|---|----|----|
| Backset mm 26 | <b>210N251</b> | 1 | 10 | 10 |
| Backset mm 31 | <b>210N301</b> | 1 | 10 | 10 |
| Backset mm 36 | <b>210N351</b> | 1 | 10 | 10 |

Version with cylinder or gold-painted finish on request



Code

Multiple  
package  
Single  
package

Min. ord.

## Infilare 200



Cylinder and striking  
plate to be ordered  
separately

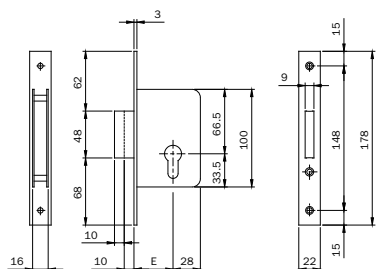

Open-case mortice lock operating with European profile cylinder.

**BRASS-PLATED STEEL FRONT PLATE** with **SQUARE EDGE**. Two mm 10 throws.

Version with deadbolt only. 2 escutcheons. Fixing screws.

|               |               |   |    |    |
|---------------|---------------|---|----|----|
| Backset mm 35 | <b>201351</b> | 1 | 10 | 10 |
| Backset mm 40 | <b>201401</b> | 1 | 10 | 10 |
| Backset mm 45 | <b>201451</b> | 1 | 10 | 10 |
| Backset mm 50 | <b>201501</b> | 1 | 10 | 10 |
| Backset mm 60 | <b>201601</b> | 1 | 10 | 10 |

Version with cylinder on request

Code  
Multiple  
package  
Single  
package  
Min. ord.

**2001**

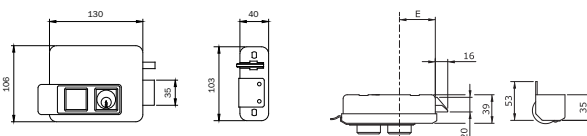

Key blank  
020259

Electric rim lock, painted, **RIGHT-HAND. 12Vac 15W**. Internal cylinder and external detached cylinder. Self-locking latchbolt. Detached self-loading spring with adjustable force.

**3 KEYS**. Adjustable keep with blade. Instructions sheets. Fixing screws.

|               |                  |   |   |   |
|---------------|------------------|---|---|---|
| Backset mm 50 | <b>521010505</b> | 1 | 6 | 6 |
| Backset mm 60 | <b>521010605</b> | 1 | 6 | 6 |
| Backset mm 70 | <b>521010705</b> | 1 | 6 | 6 |
| Backset mm 80 | <b>521010805</b> | 1 | 6 | 6 |

Electric rim lock, painted, **LEFT-HAND. 12Vac 15W**. Internal cylinder and external detached cylinder. Self-locking latchbolt. Detached self-loading spring with adjustable force.

**3 KEYS**. Adjustable keep with blade. Instructions sheets. Fixing screws.

|               |                  |   |   |   |
|---------------|------------------|---|---|---|
| Backset mm 50 | <b>521020505</b> | 1 | 6 | 6 |
| Backset mm 60 | <b>521020605</b> | 1 | 6 | 6 |
| Backset mm 70 | <b>521020705</b> | 1 | 6 | 6 |
| Backset mm 80 | <b>521020805</b> | 1 | 6 | 6 |

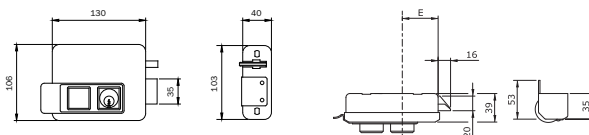

Key blank  
020259

Electric rim lock, painted, **RIGHT-HAND. 12Vac 15W**. Internal pushbutton and detached external cylinder. Self-locking latchbolt. Detached self-loading spring with adjustable force.

**3 KEYS**. Adjustable keep with blade. Instructions sheet. Fixing screws.

|               |                  |   |   |   |
|---------------|------------------|---|---|---|
| Backset mm 50 | <b>521110505</b> | 1 | 6 | 6 |
| Backset mm 60 | <b>521110605</b> | 1 | 6 | 6 |
| Backset mm 70 | <b>521110705</b> | 1 | 6 | 6 |
| Backset mm 80 | <b>521110805</b> | 1 | 6 | 6 |

Electric rim lock, painted, **LEFT-HAND. 12Vac 15W**. Internal pushbutton and detached external cylinder. Self-locking latchbolt. Detached self-loading spring with adjustable force.

**3 KEYS**. Adjustable keep with blade. Instructions sheet. Fixing screws.

|               |                  |   |   |   |
|---------------|------------------|---|---|---|
| Backset mm 50 | <b>521120505</b> | 1 | 6 | 6 |
| Backset mm 60 | <b>521120605</b> | 1 | 6 | 6 |
| Backset mm 70 | <b>521120705</b> | 1 | 6 | 6 |
| Backset mm 80 | <b>521120805</b> | 1 | 6 | 6 |

Code

Min. ord.  
Multiple  
package  
Single  
package

**2001**

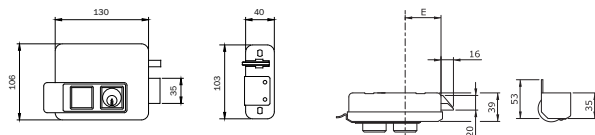

Key blank  
020259

Electric rim lock, painted, **RIGHT-HAND. 12Vac 15W**. Internal pushbutton, internal cylinder for **PUSHBUTTON LOCKING** or **HOLD-OPEN** function, and external detached cylinder. Self-locking latchbolt. Detached self-loading spring with adjustable force. **3 KEYS**. Adjustable keep with blade. Instructions sheet. Fixing screws.

|               |                  |   |   |   |
|---------------|------------------|---|---|---|
| Backset mm 50 | <b>521310505</b> | 1 | 6 | 6 |
| Backset mm 60 | <b>521310605</b> | 1 | 6 | 6 |
| Backset mm 70 | <b>521310705</b> | 1 | 6 | 6 |
| Backset mm 80 | <b>521310805</b> | 1 | 6 | 6 |

Electric rim lock, painted, **LEFT-HAND. 12Vac 15W**. Internal pushbutton, internal cylinder for **PUSHBUTTON LOCKING** or **HOLD-OPEN** function, and external detached cylinder. Self-locking latchbolt. Detached self-loading spring with adjustable force. **3 KEYS**. Adjustable keep with blade. Instructions sheet. Fixing screws.

|               |                  |   |   |   |
|---------------|------------------|---|---|---|
| Backset mm 50 | <b>521320505</b> | 1 | 6 | 6 |
| Backset mm 60 | <b>521320605</b> | 1 | 6 | 6 |
| Backset mm 70 | <b>521320705</b> | 1 | 6 | 6 |

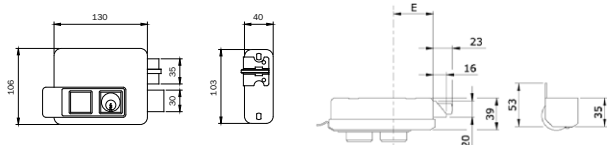

Key blank  
020259

Electric rim lock, painted, **RIGHT-HAND. 12Vac 15W**. Internal cylinder and external detached cylinder. Two throws. Self-locking latchbolt with built-in loading spring with adjustable force. **3 KEYS**. Adjustable keep with blade. Instructions sheet. Fixing screws.

|               |                  |   |   |   |
|---------------|------------------|---|---|---|
| Backset mm 50 | <b>531010505</b> | 1 | 6 | 6 |
| Backset mm 60 | <b>531010605</b> | 1 | 6 | 6 |
| Backset mm 70 | <b>531010705</b> | 1 | 6 | 6 |
| Backset mm 80 | <b>531010805</b> | 1 | 6 | 6 |

Electric rim lock, painted, **LEFT-HAND. 12Vac 15W**. Internal cylinder and external detached cylinder. Two throws. Self-locking latchbolt with built-in loading spring with adjustable force. **3 KEYS**. Adjustable keep with blade. Instructions sheet. Fixing screws.

|               |                  |   |   |   |
|---------------|------------------|---|---|---|
| Backset mm 50 | <b>531020505</b> | 1 | 6 | 6 |
| Backset mm 60 | <b>531020605</b> | 1 | 6 | 6 |
| Backset mm 80 | <b>531020805</b> | 1 | 6 | 6 |

Code  
Multiple  
package  
Single  
package  
Min. ord.

**2001**

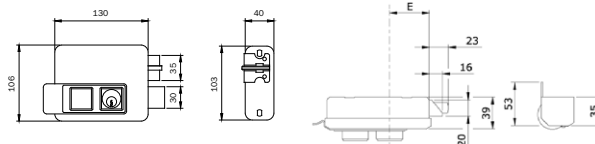

Key blank  
020259

Electric rim lock, painted, **RIGHT-HAND. 12Vac 15W.**

Internal pushbutton. Two throws operated by internal cylinder and external detached cylinder.

Self-locking latchbolt with built-in loading spring with adjustable force. **3 KEYS.**

Adjustable keep with blade. Instructions sheet. Fixing screws.

|               |                  |   |   |   |
|---------------|------------------|---|---|---|
| Backset mm 50 | <b>531210505</b> | 1 | 6 | 6 |
| Backset mm 60 | <b>531210605</b> | 1 | 6 | 6 |
| Backset mm 70 | <b>531210705</b> | 1 | 6 | 6 |
| Backset mm 80 | <b>531210805</b> | 1 | 6 | 6 |

Electric rim lock, painted, **LEFT-HAND. 12Vac 15W.** Internal pushbutton.

Two throws operated by internal cylinder and external detached cylinder. Self-locking latchbolt

with built-in loading spring with adjustable force. **3 KEYS.** Adjustable keep with blade.

Instructions sheet. Fixing screws.

|               |                  |   |   |   |
|---------------|------------------|---|---|---|
| Backset mm 50 | <b>531220505</b> | 1 | 6 | 6 |
| Backset mm 60 | <b>531220605</b> | 1 | 6 | 6 |
| Backset mm 70 | <b>531220705</b> | 1 | 6 | 6 |
| Backset mm 80 | <b>531220805</b> | 1 | 6 | 6 |

**Doors opening direction.**

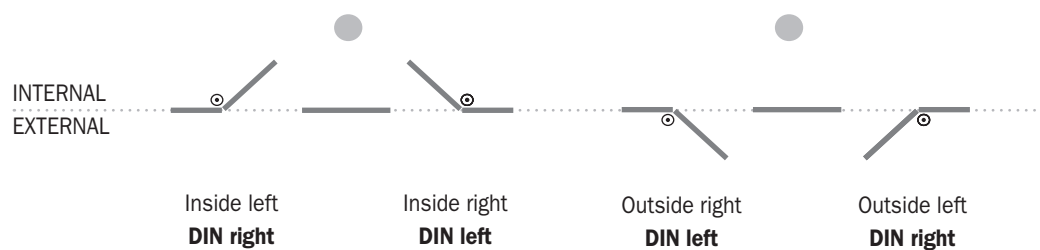

Code

Min. ord.  
Multiple  
package  
Single  
package

## Elettrica 500

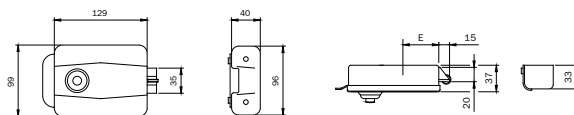

Key blank  
020259

Electric rim lock, painted, **LEFT- OR RIGHT-HAND. 12Vac 15W.**

Internal pushbutton and external detached cylinder. Self-locking latchbolt with built-in loading spring.

**3 KEYS.** Adjustable keep. Instructions sheet.

|               |               |   |    |    |
|---------------|---------------|---|----|----|
| Backset mm 50 | <b>511500</b> | 1 | 10 | 10 |
| Backset mm 60 | <b>511600</b> | 1 | 10 | 10 |
| Backset mm 70 | <b>511700</b> | 1 | 10 | 10 |
| Backset mm 80 | <b>511800</b> | 1 | 10 | 10 |

Code  
Multiple  
package  
Single  
package  
Min. ord.

## Portoncino

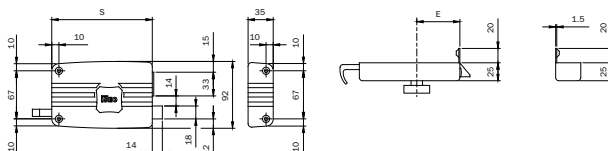

Rim lock, **RIGHT-HAND**, with internal knob and external detached cylinder, separate latchbolt with internal rod and external latchlocking by key. **3 KEYS**. Keep. Screws.

|                                 |               |   |    |    |
|---------------------------------|---------------|---|----|----|
| 2-throw deadbolt. Backset mm 40 | <b>401402</b> | 1 | 10 | 10 |
| 2-throw deadbolt. Backset mm 50 | <b>401502</b> | 1 | 10 | 10 |
| 3-throw deadbolt. Backset mm 60 | <b>401603</b> | 1 | 10 | 10 |
| 3-throw deadbolt. Backset mm 70 | <b>401703</b> | 1 | 10 | 10 |



Key blank  
020259

| Code   | S   |
|--------|-----|
| 40*402 | 80  |
| 40*502 | 100 |
| 40*603 | 120 |
| 40*703 | 140 |

Rim lock, **LEFT-HAND**, with internal knob and external detached cylinder, separate latchbolt with internal rod and external latchlocking by key. **3 KEYS**. Keep. Screws.

|                                 |               |   |    |    |
|---------------------------------|---------------|---|----|----|
| 2-throw deadbolt. Backset mm 40 | <b>402402</b> | 1 | 10 | 10 |
| 2-throw deadbolt. Backset mm 50 | <b>402502</b> | 1 | 10 | 10 |
| 3-throw deadbolt. Backset mm 60 | <b>402603</b> | 1 | 10 | 10 |
| 3-throw deadbolt. Backset mm 70 | <b>402703</b> | 1 | 10 | 10 |

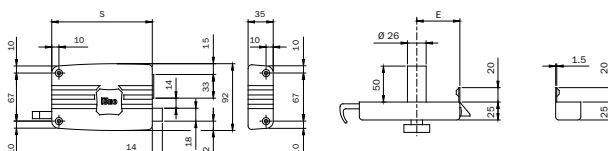

Rim lock, **RIGHT-HAND**, with internal knob and fixed external cylinder  $\varnothing$  mm 26x50, separate latchbolt with internal rod and external latchlocking by key. **3 KEYS**. Keep. Escutcheon.

|                                 |               |   |    |    |
|---------------------------------|---------------|---|----|----|
| 2-throw deadbolt. Backset mm 40 | <b>411402</b> | 2 | 10 | 10 |
| 2-throw deadbolt. Backset mm 50 | <b>411502</b> | 2 | 10 | 10 |
| 3-throw deadbolt. Backset mm 60 | <b>411603</b> | 2 | 10 | 10 |
| 3-throw deadbolt. Backset mm 70 | <b>411703</b> | 2 | 10 | 10 |



Key blank  
020259

| Code   | S   |
|--------|-----|
| 41*402 | 80  |
| 41*502 | 100 |
| 41*603 | 120 |
| 41*703 | 140 |

Rim lock, **LEFT-HAND**, with internal knob and fixed external cylinder  $\varnothing$  mm 26x50, separate latchbolt with internal rod and external latchlocking by key. **3 KEYS**. Keep. Escutcheon.

|                                 |               |   |    |    |
|---------------------------------|---------------|---|----|----|
| 2-throw deadbolt. Backset mm 40 | <b>412402</b> | 2 | 10 | 10 |
| 2-throw deadbolt. Backset mm 50 | <b>412502</b> | 2 | 10 | 10 |
| 3-throw deadbolt. Backset mm 60 | <b>412603</b> | 2 | 10 | 10 |
| 3-throw deadbolt. Backset mm 70 | <b>412703</b> | 2 | 10 | 10 |

Code  
Multiple  
package  
Single  
package  
Min. ord.

**Portoncino**

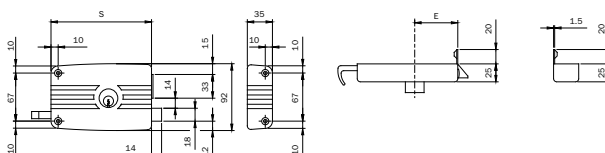

Key blank  
020259

| Code   | S   |
|--------|-----|
| 42*402 | 80  |
| 42*502 | 100 |
| 42*603 | 120 |
| 42*703 | 140 |

Rim lock, **RIGHT-HAND**, with internal cylinder and external detached cylinder, separate latchbolt with internal rod and external latchlocking by key. **3 KEYS**. Keep. Screws.

|                                 |               |   |    |    |
|---------------------------------|---------------|---|----|----|
| 2-throw deadbolt. Backset mm 40 | <b>421402</b> | 1 | 10 | 10 |
| 2-throw deadbolt. Backset mm 50 | <b>421502</b> | 1 | 10 | 10 |
| 3-throw deadbolt. Backset mm 60 | <b>421603</b> | 1 | 10 | 10 |
| 3-throw deadbolt. Backset mm 70 | <b>421703</b> | 1 | 10 | 10 |

Rim lock, **LEFT-HAND**, with internal cylinder and external detached cylinder, separate latchbolt with internal rod and external latchlocking by key. **3 KEYS**. Keep. Screws.

|                                 |               |   |    |    |
|---------------------------------|---------------|---|----|----|
| 2-throw deadbolt. Backset mm 40 | <b>422402</b> | 1 | 10 | 10 |
| 2-throw deadbolt. Backset mm 50 | <b>422502</b> | 1 | 10 | 10 |
| 3-throw deadbolt. Backset mm 60 | <b>422603</b> | 1 | 10 | 10 |
| 3-throw deadbolt. Backset mm 70 | <b>422703</b> | 1 | 10 | 10 |

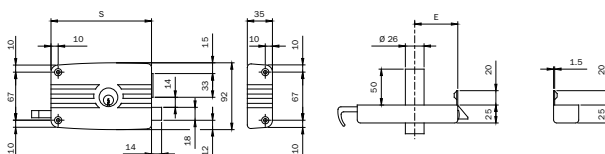

Key blank  
020259

| Code   | S   |
|--------|-----|
| 43*402 | 80  |
| 43*502 | 100 |
| 43*603 | 120 |
| 43*703 | 140 |

Rim lock, **RIGHT-HAND**, with internal cylinder and fixed external cylinder Ø mm 26x50, separate latchbolt with internal rod and external latchlocking by key. **3 KEYS**. Keep. Escutcheon.

|                                 |               |   |    |    |
|---------------------------------|---------------|---|----|----|
| 2-throw deadbolt. Backset mm 40 | <b>431402</b> | 2 | 10 | 10 |
| 2-throw deadbolt. Backset mm 50 | <b>431502</b> | 2 | 10 | 10 |
| 3-throw deadbolt. Backset mm 60 | <b>431603</b> | 2 | 10 | 10 |
| 3-throw deadbolt. Backset mm 70 | <b>431703</b> | 2 | 10 | 10 |

Rim lock, **LEFT-HAND**, with internal cylinder and fixed external cylinder Ø mm 26x50, separate latchbolt with internal rod and external latchlocking by key. **3 KEYS**. Keep. Escutcheon.

|                                 |               |   |    |    |
|---------------------------------|---------------|---|----|----|
| 2-throw deadbolt. Backset mm 40 | <b>432402</b> | 2 | 10 | 10 |
| 2-throw deadbolt. Backset mm 50 | <b>432502</b> | 2 | 10 | 10 |
| 3-throw deadbolt. Backset mm 60 | <b>432603</b> | 2 | 10 | 10 |
| 3-throw deadbolt. Backset mm 70 | <b>432703</b> | 2 | 10 | 10 |

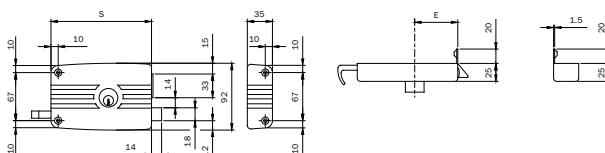

Key blank  
020259

| Code    | S   |
|---------|-----|
| 42*502E | 100 |
| 42*603E | 120 |
| 42*703E | 140 |

Rim lock for wooden frames, **RIGHT-HAND**, with internal cylinder and external detached cylinder, separate latchbolt with internal rod and external latchlocking by key. **3 KEYS**. Keep. Screws.

**PACKAGING: 30-PIECE BOX.**

|                                 |                |   |    |    |
|---------------------------------|----------------|---|----|----|
| 2-throw deadbolt. Backset mm 50 | <b>421502E</b> | 2 | 30 | 30 |
| 3-throw deadbolt. Backset mm 60 | <b>421603E</b> | 2 | 30 | 30 |
| 3-throw deadbolt. Backset mm 70 | <b>421703E</b> | 2 | 30 | 30 |





Code  
Multiple  
package  
Single  
package  
Min. ord.

**Portoncino**



Key blank  
020259

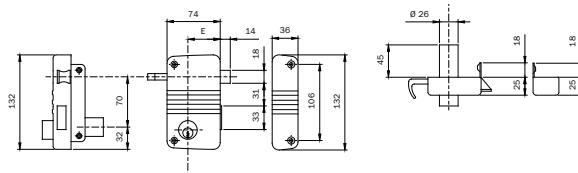

**VERTICAL, RIGHT-HAND** rim lock. Internal cylinder and external fixed cylinder Ø mm 26x50, separate latchbolt with internal rod and external latching by key. 2-throw deadbolt. Backset mm 45. **3 KEYS.** Keep. Escutcheon.

**425010450** 2 10 10

**VERTICAL, LEFT-HAND** rim lock. Internal cylinder and external fixed cylinder Ø mm 26x50, separate latchbolt with internal rod and external latching by key. 2-throw deadbolt. Backset mm 45. **3 KEYS.** Keep. Escutcheon.

**425020450** 2 10 10



Key blank  
020259

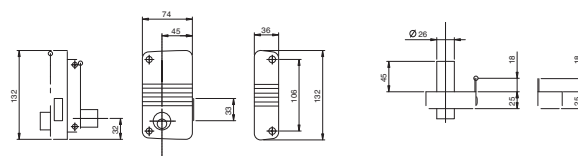

**VERTICAL, RIGHT-HAND** rim lock. Internal cylinder and external fixed cylinder Ø mm 26x50, 2-throw deadbolt. Backset mm 45. **3 KEYS.** Keep. Escutcheon.

**435010450** 2 10 10

**VERTICAL, LEFT-HAND** rim lock. Internal cylinder and external fixed cylinder Ø mm 26x50, 2-throw deadbolt. Backset mm 45. **3 KEYS.** Keep. Escutcheon.

**435020450** 2 10 10



Key blank  
020259

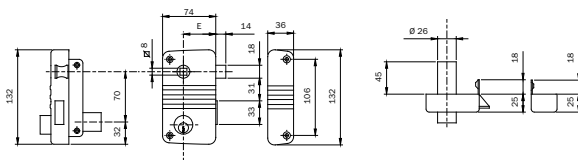

**VERTICAL, RIGHT-HAND** rim lock. Internal cylinder and external fixed cylinder Ø mm 26x50. Separate latchbolt, handle follower mm 8. Centre distance cylinder follower mm 70. 2-throw deadbolt. Backset mm 45. **3 KEYS.** Keep. Escutcheon.

**495018450** 2 10 10

**VERTICAL, LEFT-HAND** rim lock. Internal cylinder and external fixed cylinder Ø mm 26x50, Separate latchbolt, handle follower mm 8. Centre distance cylinder follower 70 mm. 2-throw deadbolt. Backset mm 45. **3 KEYS.** Keep. Escutcheon.

**495028450** 2 10 10

Code

Multiple  
package  
Single  
package

Min. ord.

## Ferroglietto

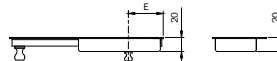
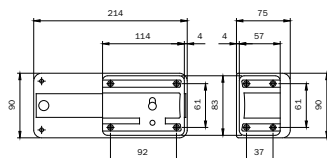

Key blank  
020259

Rim lock, with internal unlatching knob and **EXTERNAL DETACHED CYLINDER,**  
**3 KEYS. 6-THROW DEADBOLT.** Keep. Screws.

|               |               |   |    |    |
|---------------|---------------|---|----|----|
| Backset mm 40 | <b>300406</b> | 2 | 10 | 10 |
| Backset mm 50 | <b>300506</b> | 2 | 10 | 10 |
| Backset mm 60 | <b>300606</b> | 2 | 10 | 10 |

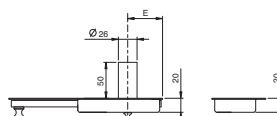
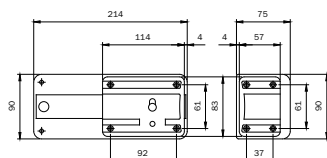

Key blank  
020259

Rim lock, with internal unlatching knob and **EXTERNAL FIXED CYLINDER** Ø mm 26x50  
**3 KEYS. 6-THROW DEADBOLT.** Keep. Escutcheon.

|               |               |   |    |    |
|---------------|---------------|---|----|----|
| Backset mm 40 | <b>310406</b> | 2 | 10 | 10 |
| Backset mm 50 | <b>310506</b> | 2 | 10 | 10 |
| Backset mm 60 | <b>310606</b> | 2 | 10 | 10 |

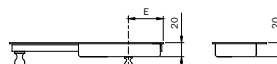
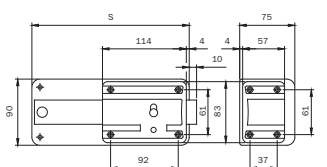

Key blank  
020259

Rim lock, with internal unlatching knob and **EXTERNAL DETACHED CYLINDER,**  
**3 KEYS. 5-THROW DEADBOLT + BUILT-IN LATCHBOLT.** Keep. Screws.

|               |               |   |    |    |
|---------------|---------------|---|----|----|
| Backset mm 40 | <b>320405</b> | 2 | 10 | 10 |
| Backset mm 50 | <b>320505</b> | 2 | 10 | 10 |
| Backset mm 60 | <b>320605</b> | 2 | 10 | 10 |

Rim lock, with internal unlatching knob and **EXTERNAL DETACHED CYLINDER,**  
**3 KEYS. 7-THROW DEADBOLT + BUILT-IN LATCHBOLT.** Keep. Screws.

|               |               |   |    |    |
|---------------|---------------|---|----|----|
| Backset mm 40 | <b>320407</b> | 2 | 10 | 10 |
| Backset mm 50 | <b>320507</b> | 2 | 10 | 10 |
| Backset mm 60 | <b>320607</b> | 2 | 10 | 10 |



Code

Min. ord.  
Multiple  
package  
Single  
package

**Verrou**

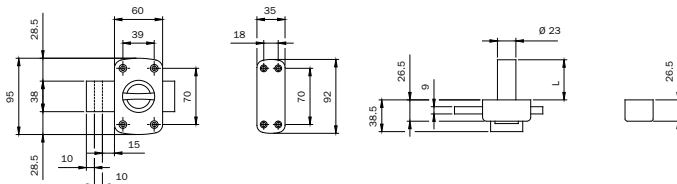

Key blank  
020259

Rim lock, painted, **BOTH RIGHT- AND LEFT HAND**. Internal knob and external cylinder  $\varnothing$  26.  
Two mm 10 throws. Keep, cylinder escutcheon, assembly template,  
fixing screws, **3 KEYS**.

|                       |               |   |    |    |
|-----------------------|---------------|---|----|----|
| Cylinder length mm 40 | <b>460400</b> | 1 | 10 | 10 |
| Cylinder length mm 45 | <b>460450</b> | 1 | 10 | 10 |
| Cylinder length mm 50 | <b>460500</b> | 1 | 10 | 10 |
| Cylinder length mm 60 | <b>460600</b> | 1 | 10 | 10 |

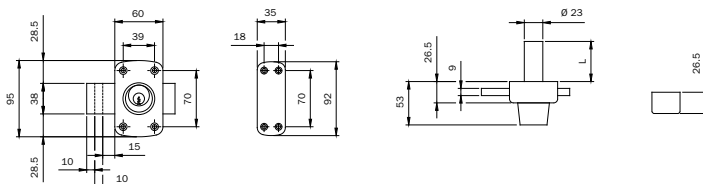

Key blank  
020259

Rim lock, painted, **BOTH RIGHT- AND LEFT HAND**. Double cylinder  $\varnothing$  26.  
Two mm 10 throws. Keep, cylinder escutcheon, assembly template,  
fixing screws, **3 KEYS**.

|                       |               |   |    |    |
|-----------------------|---------------|---|----|----|
| Cylinder length mm 40 | <b>470400</b> | 1 | 10 | 10 |
| Cylinder length mm 45 | <b>470450</b> | 1 | 10 | 10 |
| Cylinder length mm 50 | <b>470500</b> | 1 | 10 | 10 |
| Cylinder length mm 60 | <b>470600</b> | 1 | 10 | 10 |

Code  
Multiple  
package  
Single  
package  
Min. ord.

## Furniture locks

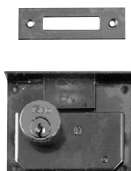

Key blank  
020149

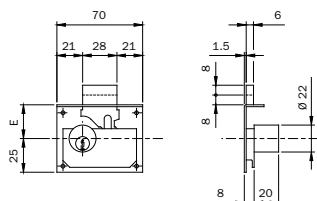

**FITTING** furniture lock, zinc-plated case, brass cylinder Ø mm 22x20.

Escutcheon and striking plate.

|                         |               |    |   |    |
|-------------------------|---------------|----|---|----|
| Backset mm 25. 1 throw  | <b>100251</b> | 10 | - | 10 |
| Backset mm 30. 2 throws | <b>100301</b> | 10 | - | 10 |
| Backset mm 35. 2 throws | <b>100351</b> | 10 | - | 10 |
| Backset mm 40. 2 throws | <b>100401</b> | 10 | - | 10 |
| Backset mm 45. 2 throws | <b>100451</b> | 10 | - | 10 |
| Backset mm 50. 2 throws | <b>100501</b> | 10 | - | 10 |

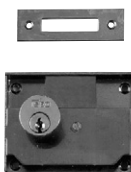

Key blank  
020149

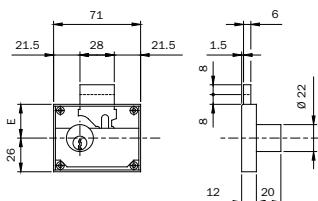

**RIM** furniture lock, zinc-plated case, brass cylinder Ø mm 22x20.

Escutcheon and striking plate.

|                         |               |    |   |    |
|-------------------------|---------------|----|---|----|
| Backset mm 25. 1 throw  | <b>102251</b> | 10 | - | 10 |
| Backset mm 30. 2 throws | <b>102301</b> | 10 | - | 10 |
| Backset mm 35. 2 throws | <b>102351</b> | 10 | - | 10 |
| Backset mm 40. 2 throws | <b>102401</b> | 10 | - | 10 |
| Backset mm 50. 2 throws | <b>102501</b> | 10 | - | 10 |

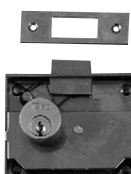

Key blank  
020149

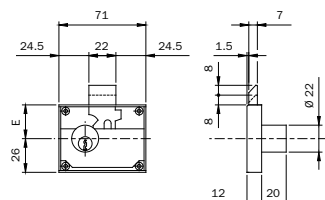

**RIM** furniture lock, zinc-plated case, brass cylinder Ø mm 22x20.

Escutcheon and striking plate.

|  |               |    |   |    |
|--|---------------|----|---|----|
| Backset mm 30. 1 throw with built-in latchbolt | <b>103301</b> | 10 | - | 10 |
|--|---------------|----|---|----|

Code

Multiple  
package  
Single  
package

Min. ord.

## Furniture locks



Key blank  
020149

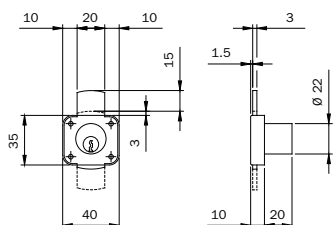

Rim lock for **DRAWER AND VERTICAL WING**, zinc-plated case.

Escutcheon. Key removal when locked.

Brass cylinder Ø mm 22x20

**106214** 10 - 10

Nickel-plated brass cylinder Ø mm 22x20

**106219** 10 - 10

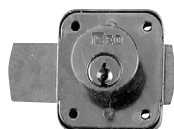

Key blank  
020149

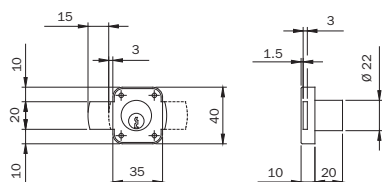

Rim lock for **RIGHT-HAND WING**, zinc-plated case.

Escutcheon. Key removal when locked.

Brass cylinder Ø mm 22x20

**107214** 10 - 10

Nickel-plated brass cylinder Ø mm 22x20

**107219** 10 - 10



Key blank  
020149

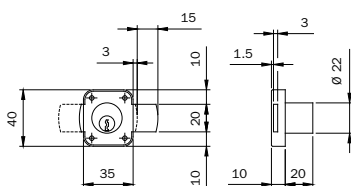

Rim lock for **LEFT-HAND WING**, zinc-plated case.

Escutcheon. Key removal when locked.

Brass cylinder Ø mm 22x20

**108214** 10 - 10

Nickel-plated brass cylinder Ø mm 22x20

**108219** 10 - 10



Code  
Multiple  
package  
Single  
package  
Min. ord.

**Accessories**



Pair of standard coils **12Vac 15W**. For rim lock series 500-505-510.

**050020** 10 - 10



Pair of standard coils **12Vac 15W**. For rim locks series 52\*\*-53\*\*.

**050035** 10 - 10

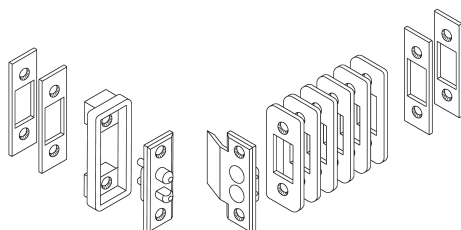

Pair of pressure electrical contacts **FOR 12V ELECTRIC LOCKS**. Six spacers mm 2x22.  
Four spacers mm 2x16. One spacer mm 5. Instructions.

**050060** 10 - 10

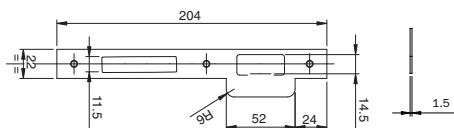

Flat striking plate, square edge, with blade, for locks for wooden frames series 200N-221-221N.

**BRASS-PLATED STEEL** mm 204x22x1,5 **032011** 10 - 10

**GOLD PAINTED STEEL** mm 204x22x1,5 **032016** 10 - 10

**BRASS** mm 204x22x1,5 **032017** 10 - 10

**CHROME-PLATED STEEL** mm 204x22x1,5 **032013** 10 - 10

**STAINLESS STEEL** mm 204x22x1,5 **032010** 10 - 10

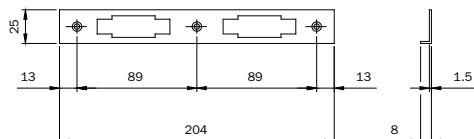

Angle striking plate for locks for wooden frames series 200N-221N.

**BRASS-PLATED STEEL** mm 204x25x8x1,5 **032021** 10 - 10

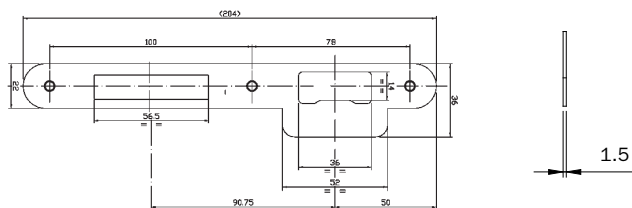

Flat striking plate, round edge, with blade, for locks for wooden frames series 210N.

**BRASS-PLATED STEEL** mm 204x22x1,5 **032031** 10 - 10

**GOLD PAINTED STEEL** mm 204x22x1,5 **032036** 10 - 10

Code

Multiple  
package  
Single  
package

Min. ord.

## Accessories

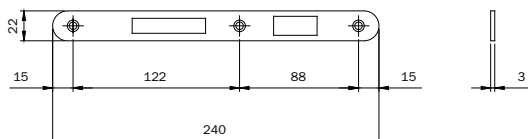

Flat, heavy striking plate, round edge, for locks for wooden frames series 210N.

**BRASS-PLATED STEEL** mm 240x22x3

**032051**

10 - 10

**CHROME-PLATED STEEL** mm 240x22x3

**032053**

10 - 10

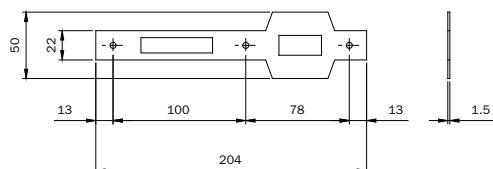

Flat striking plate, square edge, with double blade for roller locks for wooden frames series 280N.

**BRASS-PLATED STEEL** mm 204x22x1,5

**032111**

10 - 10

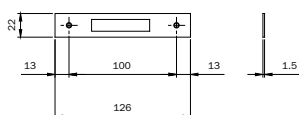

Flat striking, square edge, for locks for wooden frames with deadbolt only series 201.

**BRASS-PLATED** mm 126x22x1,5

**032071**

10 - 10



Code  
Multiple  
package  
Single  
package  
Min. ord.

## Mortice locks



| CODICE     | E  | L   |
|------------|----|-----|
| 1301.00.40 | 40 | 92  |
| 1301.00.50 | 50 | 100 |
| 1301.00.60 | 60 | 108 |
| 1301.00.70 | 70 | 118 |

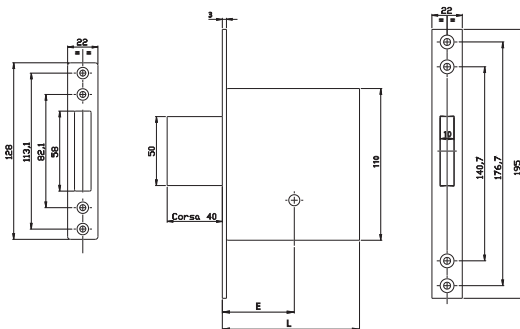

CLOSED-CASE mortice lock with DEADBOLT only.

**FOREND AND STRIKING-PLATE IN SATINATED BRASS, VARNISHED.**

Four throws. 1 cross-key KA cod. 91.01.75

|               |                   |   |   |   |
|---------------|-------------------|---|---|---|
| Backset mm 40 | <b>1301.10.40</b> | 1 | - | 1 |
| Backset mm 50 | <b>1301.10.50</b> | 1 | - | 1 |
| Backset mm 60 | <b>1301.10.60</b> | 1 | - | 1 |
| Backset mm 70 | <b>1301.10.70</b> | 1 | - | 1 |

CLOSED-CASE mortice lock with DEADBOLT only.

**FOREND AND STRIKING-PLATE IN SATINATED BRASS, VARNISHED.**

Four throws. 3 cross-keys cod. 91.01.75

|               |                   |   |   |   |
|---------------|-------------------|---|---|---|
| Backset mm 40 | <b>1301.00.40</b> | 1 | - | 1 |
| Backset mm 50 | <b>1301.00.50</b> | 1 | - | 1 |
| Backset mm 60 | <b>1301.00.60</b> | 1 | - | 1 |
| Backset mm 70 | <b>1301.00.70</b> | 1 | - | 1 |



| E  | CODICE            | CODICE KA         |
|----|-------------------|-------------------|
| 50 | <b>1321.00.50</b> | <b>1321.10.50</b> |
| 60 | <b>1321.00.60</b> | <b>1321.10.60</b> |
| 70 | <b>1321.00.70</b> | <b>1321.10.70</b> |

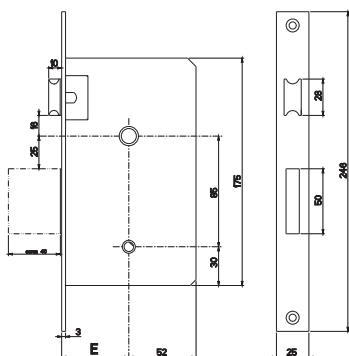

CLOSED-CASE mortice lock with LATCHBOLT AND DEADBOLT.

**FOREND AND STRIKING-PLATE IN SATINATED BRASS, VARNISHED.**

Four throws and latch. 1 cross-key KA cod. 91.01.75

|               |                   |   |   |   |
|---------------|-------------------|---|---|---|
| Backset mm 50 | <b>1321.10.50</b> | 1 | - | 1 |
| Backset mm 60 | <b>1321.10.60</b> | 1 | - | 1 |
| Backset mm 70 | <b>1321.10.70</b> | 1 | - | 1 |

CLOSED-CASE mortice lock with LATCHBOLT AND DEADBOLT.

**FOREND AND STRIKING-PLATE IN SATINATED BRASS, VARNISHED.**

Four throws and latch. 3 cross-keys cod. 91.01.75

|               |                   |   |   |   |
|---------------|-------------------|---|---|---|
| Backset mm 50 | <b>1321.00.50</b> | 1 | - | 1 |
| Backset mm 60 | <b>1321.00.60</b> | 1 | - | 1 |
| Backset mm 70 | <b>1321.00.70</b> | 1 | - | 1 |

Code  
Multiple  
package  
Single  
package  
Min. ord.

## Mortice locks



Cylinder to be ordered  
separately

| E  | CODICE     |
|----|------------|
| 50 | 1320.04.50 |
| 60 | 1321.04.60 |
| 70 | 1321.04.70 |

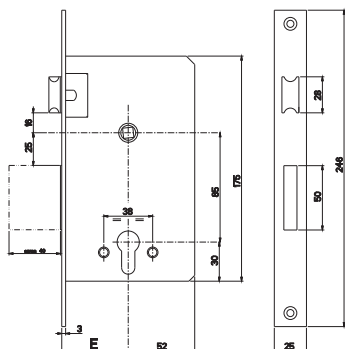

CLOSED-CASE mortice lock with LATCHBOLT AND DEADBOLT, operating with European profile cylinder.

**FOREND AND STRIKING-PLATE IN SATINATED BRASS, VARNISHED.**

Four throws and latch.

|               |                   |   |   |   |
|---------------|-------------------|---|---|---|
| Backset mm 50 | <b>1320.04.50</b> | 1 | - | 1 |
| Backset mm 60 | <b>1320.04.60</b> | 1 | - | 1 |
| Backset mm 70 | <b>1320.04.70</b> | 1 | - | 1 |

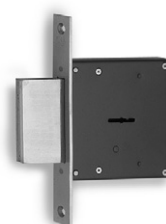

| E  | L   |
|----|-----|
| 40 | 93  |
| 50 | 113 |
| 60 | 123 |
| 70 | 133 |

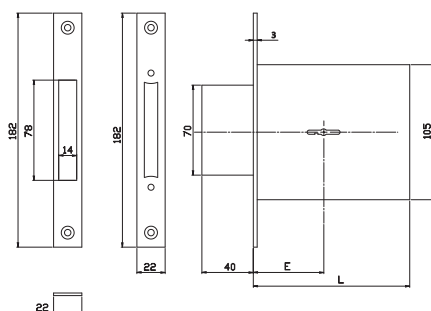

CLOSED-CASE mortice lock with DEADBOLT only.

**FOREND AND STRIKING-PLATE IN SATINATED BRASS, VARNISHED.**

Four throws. 3 double bitted keys cod. 31.00.65. Coupled locks.

|               |                   |   |   |   |
|---------------|-------------------|---|---|---|
| Backset mm 40 | <b>3131.01.40</b> | 1 | - | 1 |
| Backset mm 50 | <b>3131.01.50</b> | 1 | - | 1 |
| Backset mm 60 | <b>3131.01.60</b> | 1 | - | 1 |
| Backset mm 70 | <b>3131.01.70</b> | 1 | - | 1 |

CLOSED-CASE mortice lock with DEADBOLT only.

**FOREND AND STRIKING-PLATE IN SATINATED BRASS, VARNISHED.**

Four throws. 1 double bitted key KA. cod. 31.00.65.

|               |                   |   |   |   |
|---------------|-------------------|---|---|---|
| Backset mm 40 | <b>3131.10.40</b> | 1 | - | 1 |
| Backset mm 50 | <b>3131.10.50</b> | 1 | - | 1 |
| Backset mm 60 | <b>3131.10.60</b> | 1 | - | 1 |
| Backset mm 70 | <b>3131.10.70</b> | 1 | - | 1 |

CLOSED-CASE mortice lock with DEADBOLT only.

**FOREND AND STRIKING-PLATE IN SATINATED BRASS, VARNISHED.**

Four throws. 3 double bitted keys cod. 31.00.65.

|               |                   |   |   |   |
|---------------|-------------------|---|---|---|
| Backset mm 40 | <b>3131.00.40</b> | 1 | - | 1 |
| Backset mm 50 | <b>3131.00.50</b> | 1 | - | 1 |
| Backset mm 60 | <b>3131.00.60</b> | 1 | - | 1 |
| Backset mm 70 | <b>3131.00.70</b> | 1 | - | 1 |

Code  
Multiple  
package  
Single  
package  
Min. ord.

## Mortice locks



| E  | L   |
|----|-----|
| 50 | 113 |
| 60 | 123 |
| 70 | 133 |

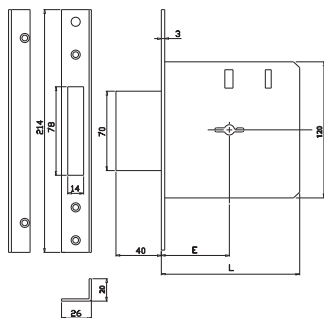

CLOSED-CASE mortice lock with DEADBOLT only. **FOREND AND STRIKING-PLATE IN SATINATED BRASS, VARNISHED.**

Four throws. 3 double bitted keys cod. 40.00.75. Coupled locks.

|               |                   |   |   |   |
|---------------|-------------------|---|---|---|
| Backset mm 50 | <b>3132.01.50</b> | 1 | - | 1 |
| Backset mm 60 | <b>3132.01.60</b> | 1 | - | 1 |
| Backset mm 70 | <b>3132.01.70</b> | 1 | - | 1 |

CLOSED-CASE mortice lock with DEADBOLT only. **FOREND AND STRIKING-PLATE IN SATINATED BRASS, VARNISHED.**

Four throws. 1 double bitted key KA. cod. 40.00.75.

|               |                   |   |   |   |
|---------------|-------------------|---|---|---|
| Backset mm 50 | <b>3132.10.50</b> | 1 | - | 1 |
| Backset mm 60 | <b>3132.10.60</b> | 1 | - | 1 |
| Backset mm 70 | <b>3132.10.70</b> | 1 | - | 1 |

CLOSED-CASE mortice lock with DEADBOLT only. **FOREND AND STRIKING-PLATE IN SATINATED BRASS, VARNISHED.**

Four throws. 3 double bitted keys cod. 40.00.75.

|               |                   |   |   |   |
|---------------|-------------------|---|---|---|
| Backset mm 50 | <b>3132.00.50</b> | 1 | - | 1 |
| Backset mm 60 | <b>3132.00.60</b> | 1 | - | 1 |
| Backsetmm 70  | <b>3132.00.70</b> | 1 | - | 1 |



| CODICE            | E         | L          |
|-------------------|-----------|------------|
| <b>3133.00.60</b> | <b>60</b> | <b>122</b> |
| <b>3133.00.70</b> | <b>70</b> | <b>132</b> |

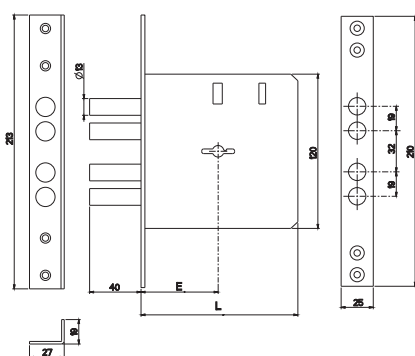

CLOSED-CASE mortice lock with DEADBOLT only. **FOREND AND STRIKING-PLATE IN SATINATED BRASS, VARNISHED.**

Four throws. 3 double bitted keys cod. 40.00.75. Coupled locks.

|               |                   |   |   |   |
|---------------|-------------------|---|---|---|
| Backset mm 60 | <b>3133.01.60</b> | 1 | - | 1 |
| Backset mm 70 | <b>3133.01.70</b> | 1 | - | 1 |

CLOSED-CASE mortice lock with DEADBOLT only. **FOREND AND STRIKING-PLATE IN SATINATED BRASS, VARNISHED.**

Four throws. 1 double bitted key KA. cod. 40.00.75.

|               |                   |   |   |   |
|---------------|-------------------|---|---|---|
| Backset mm 60 | <b>3133.10.60</b> | 1 | - | 1 |
| Backset mm 70 | <b>3133.10.70</b> | 1 | - | 1 |

CLOSED-CASE mortice lock with DEADBOLT only. **FOREND AND STRIKING-PLATE IN SATINATED BRASS, VARNISHED.**

Four throws. 3 double bitted keys cod. 40.00.75.

|               |                   |   |   |   |
|---------------|-------------------|---|---|---|
| Backset mm 60 | <b>3133.00.60</b> | 1 | - | 1 |
| Backset mm 70 | <b>3133.00.70</b> | 1 | - | 1 |

Code  
Multiple  
package  
Single  
package  
Min. ord.

## Mortice locks



|   |     |     |     |
|---|-----|-----|-----|
| E | 50  | 60  | 70  |
| L | 113 | 123 | 133 |

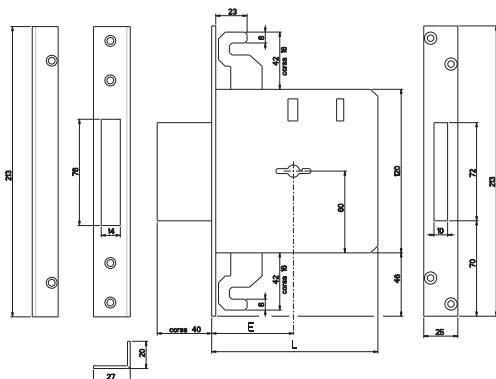

CLOSED-CASE mortice lock with DEADBOLT only.

**FOREND AND STRIKING-PLATE IN SATINATED BRASS, VARNISHED.**

Four throws. Three locking points. 1 double bitted key KA. cod. 40.00.75.

Backset mm 60

**3134.10.60** 1 - 1

Backset mm 70

**3134.10.70** 1 - 1

CLOSED-CASE mortice lock with DEADBOLT only.

**FOREND AND STRIKING-PLATE IN SATINATED BRASS, VARNISHED.**

Four throws. Three locking points. 3 double bitted keys cod. 40.00.75.

Backset mm 60

**3134.00.60** 1 - 1

Backset mm 70

**3134.00.70** 1 - 1



|   |     |     |     |
|---|-----|-----|-----|
| E | 50  | 60  | 70  |
| L | 113 | 123 | 133 |

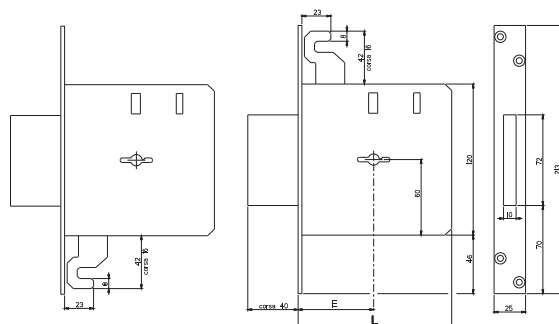

CLOSED-CASE mortice lock with DEADBOLT only.

**FOREND AND STRIKING-PLATE IN SATINATED BRASS, VARNISHED.**

Coupled locks. Four throws. Four locking points.

Double bitted keys n.3. Cod. 40.00.95.

Backset mm 60

**3135.01.60** 1 - 1

Backset mm 70

**3135.01.70** 1 - 1

CLOSED-CASE mortice lock with DEADBOLT only.

**FOREND AND STRIKING-PLATE IN SATINATED BRASS, VARNISHED.**

Coupled locks. Four throws. Four locking points.

Double bitted keys n.3. Cod. 40.00.75.

Backset mm 60

**3135.00.60** 1 - 1

Backset mm 70

**3135.00.70** 1 - 1



Code

Min. ord.  
Multiple  
package  
Single  
package

## Mortice locks with cylinder

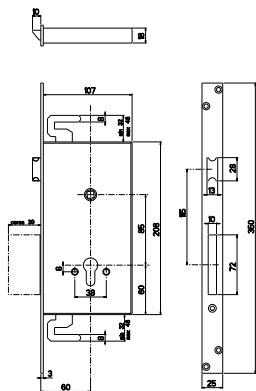

Mortice locks operating with European-profile cylinder.  
Three throws and latch, forend in chrome-plated steel, three locking points, zinc-plated.  
Backset 60

**463.04.60**

1 10 10

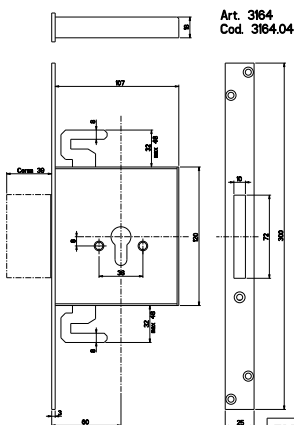

Mortice locks with cylinde, operating with European-profile cylinder.  
Three throws and latch, forend in chrome-plated steel, three locking points, zinc-plated.  
Backset 60

**3164.04.60**

1 10 10

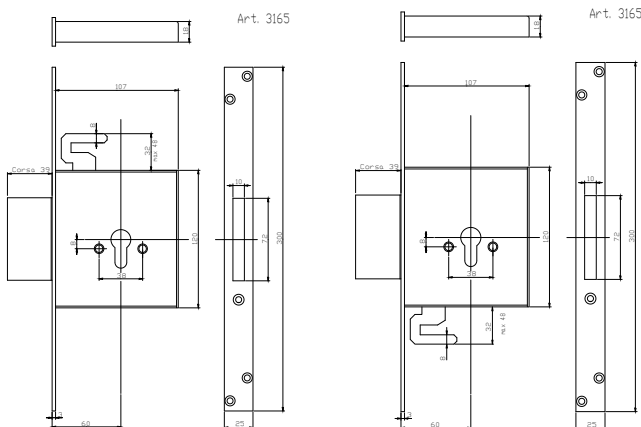

Mortice locks with cylinde, operating with European-profile cylinder.  
Coupled locks, three throws, four locking points, forends  
in chrome-plated steel, zinc-plated.

Backset 60

**3165.01.60**

1 10 10

Code  
Multiple  
package  
Single  
package  
Min. ord.

## Accessories

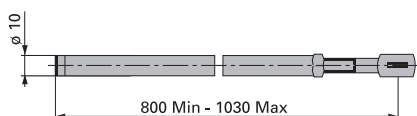

Adjustable rod, anti-saw tips.  
For item 3134.

**9999.00.16** 1 10 10

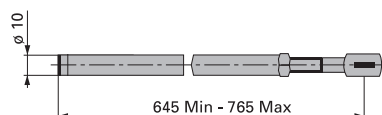

Adjustable rod, anti-saw tips.  
For item 3134 AB.

**9999.00.14** 1 10 10

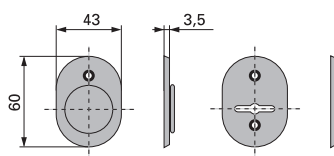

Set of escutcheons, in polished brass.  
For item 3131/3132/3133/3134/3134 AB.  
right-hand

**98.02.0121** 1 10 10

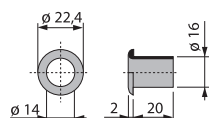

Floor socket, in polished brass  
For locks with rods

|         |                         |   |    |    |
|---------|-------------------------|---|----|----|
| Ø 14 mm | <b>192.00.0000.4027</b> | 1 | 10 | 10 |
| Ø 18 mm | <b>192.00.0000.4029</b> | 1 | 10 | 10 |

Code  
Multiple  
package  
Single  
package  
Min. ord.

## Accessories

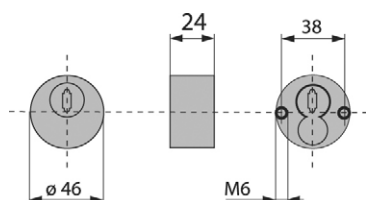

**ONE.** Escutcheon  
In tempered steel  
Included fixing screws M6.

|                                 |                   |   |    |    |
|---------------------------------|-------------------|---|----|----|
| <b>BLACK VARNISHED</b>          | <b>98.01.4624</b> | 1 | 10 | 10 |
| <b>POLISHED BRASS VARNISHED</b> | <b>98.02.4624</b> | 1 | 10 | 10 |
| <b>SATIN CHROME</b>             | <b>98.03.4624</b> | 1 | 10 | 10 |
| <b>POLISHED CHROME</b>          | <b>98.04.4624</b> | 1 | 10 | 10 |

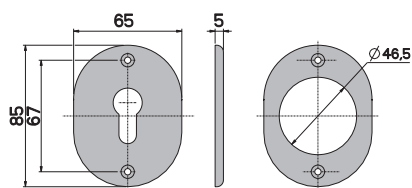

Set of escutcheons

|                                 |                   |   |    |    |
|---------------------------------|-------------------|---|----|----|
| <b>POLISHED BRASS VARNISHED</b> | <b>98.0B.3120</b> | 1 | 10 | 10 |
|---------------------------------|-------------------|---|----|----|

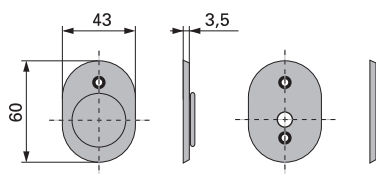

Set of escutcheons

|   |                   |   |    |    |
|---|-------------------|---|----|----|
| for item 1300 K/1320 K - <b>BRASS PLATED</b>                | <b>98.01.1301</b> | 1 | 10 | 10 |
| for item 1200 K/1203 K/1400 K/1500 K - <b>NICKEL-PLATED</b> | <b>98.01.1201</b> | 1 | 10 | 10 |

Code  
Multiple  
package  
Single  
package  
Min. ord.

**Sbarra**



Reversible security bar operating with European profile cylinder. Horizontal fixing.  
Chrome-plated steel base and aluminium case. Single throw with deadbolts travel  
distance mm 80 **ON THE RIGHT AND ON THE LEFT**. Pair of narrow-base rim strikers.  
One mortice striker. Internal black nylon cylinder escutcheon.  
Assembly template. Fixing screws. Instructions sheet.  
Cylinder to be order separately.

**Bar mm 700 (S)**

|                |               |   |   |   |
|----------------|---------------|---|---|---|
| BRONZE PAINTED | <b>904702</b> | 1 | - | 1 |
| WHITE PAINTED  | <b>904704</b> | 1 | - | 1 |

**Bar mm 800 (S)**

|                |               |   |   |   |
|----------------|---------------|---|---|---|
| GOLD PAINTED   | <b>904801</b> | 1 | - | 1 |
| BRONZE PAINTED | <b>904802</b> | 1 | - | 1 |
| WHITE PAINTED  | <b>904804</b> | 1 | - | 1 |

**Bar mm 850 (S)**

|                |               |   |   |   |
|----------------|---------------|---|---|---|
| GOLD PAINTED   | <b>904851</b> | 1 | - | 1 |
| BRONZE PAINTED | <b>904852</b> | 1 | - | 1 |
| WHITE PAINTED  | <b>904854</b> | 1 | - | 1 |

**Bar mm 900 (S)**

|                |               |   |   |   |
|----------------|---------------|---|---|---|
| GOLD PAINTED   | <b>904901</b> | 1 | - | 1 |
| BRONZE PAINTED | <b>904902</b> | 1 | - | 1 |
| WHITE PAINTED  | <b>904904</b> | 1 | - | 1 |

**Bar mm 970 (S)**

|                |               |   |   |   |
|----------------|---------------|---|---|---|
| GOLD PAINTED   | <b>904971</b> | 1 | - | 1 |
| BRONZE PAINTED | <b>904972</b> | 1 | - | 1 |
| WHITE PAINTED  | <b>904974</b> | 1 | - | 1 |

TO BE USED WITH CYLINDER WITH PROJECTING DIN CAM

| Door thickness<br>mm | Door length<br>mm | Cylinder code |       | * |
|----------------------|-------------------|---------------|-------|---|
|                      |                   | C             | D     |   |
| 40                   | 85                | 8**9          | 30 55 | * |
| 45                   | 90                | 8**9          | 30 60 | * |
| 55                   | 100               | 8**9          | 30 70 | * |
| 65                   | 110               | 8**9          | 30 80 | * |

Code  
Single  
Multiple  
package  
Min. ord.

## Accessories



External plate with hole for European profile cylinder for bar series 904\*.  
In zamak. Inside fixing with screws.

|                |                |   |   |   |
|----------------|----------------|---|---|---|
| CHROME PLATED  | <b>990901</b>  | 1 | - | 1 |
| BRONZE PAINTED | <b>9909012</b> | 1 | - | 1 |
| WHITE PAINTED  | <b>9909014</b> | 1 | - | 1 |



External plate for bar series 904\*, with anti-drill disk in steel.  
Anti-drill balls for screws. Gasket. Adjustable escutcheon.  
Inside fixing by screws.

|                |               |   |   |   |
|----------------|---------------|---|---|---|
| BRONZE PAINTED | <b>990982</b> | 1 | - | 1 |
| WHITE PAINTED  | <b>990984</b> | 1 | - | 1 |



Narrow-base striker with built-in slide guard for bars series 904\*. Three spacers mm 2.  
Three spacers mm 5. One nylon fork with one spacer. Screws.

|                     |               |   |   |   |
|---------------------|---------------|---|---|---|
| BRONZE PAINTED case | <b>990972</b> | 1 | - | 1 |
| WHITE PAINTED case  | <b>990974</b> | 1 | - | 1 |

Code

Multiple  
package  
Single  
package

Min. ord.

## Accessories

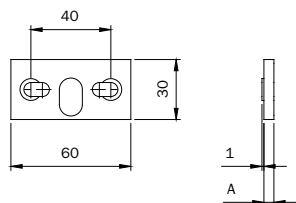

Spacer for narrow-base striker for bar series 904\*.  
CHROME-PLATED ABS mm 2

**990904**

10 - 10

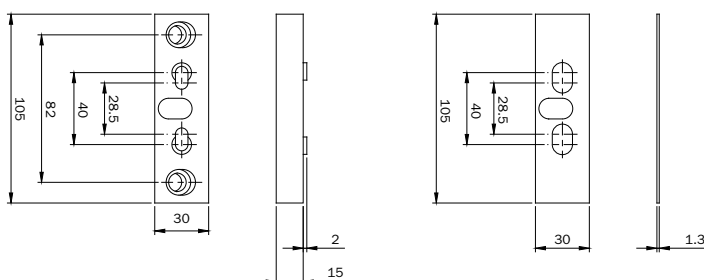

Pair of spacers for narrow-base striker for bar series 904\*.

One in CHROME-PLATED steel mm 1,3. One in CHROME-PLATED zamak mm 15

**990929**

10 - 10

Code

Multiple  
package  
Single  
package

Min. ord.

**Perfecta**

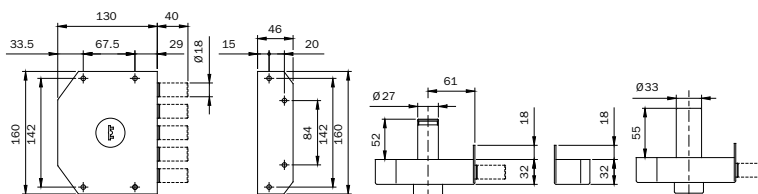
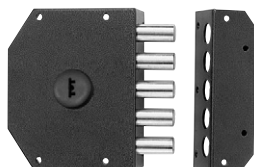

PERFECTA security rim lock. BRONZE painted. **LATERAL LOCKING** with 5 loading springs  $\varnothing$  mm 18. Four mm 10 throws. **INTERNAL KEY-GUIDE**. 3 PUMP KEYS. One ABS keyhead. Painted anti-break tube for cylinder  $\varnothing$  mm 33. Nickel plated brass escutcheon  $\varnothing$  mm 33. Striker with blade. Fixing screws.

RIGHT-HAND. External pump cylinder mm 50

**911005/D** 1 - 1

RIGHT-HAND. External pump cylinder mm 60

**911005/D.60** 1 - 1

LEFT-HAND. External pump cylinder mm 50

**911005/S** 1 - 1

LEFT-HAND. External pump cylinder mm 60

**911005/S.60** 1 - 1

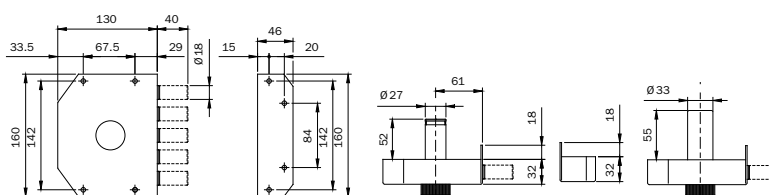

PERFECTA security rim lock. BRONZE painted. **LATERAL LOCKING** with 4 loading springs  $\varnothing$  mm 18. Four mm 10 throws. **INTERNAL KNOB**. 3 PUMP KEYS. One ABS keyhead. Painted anti-break tube for cylinder  $\varnothing$  mm 33. Nickel plated brass escutcheon  $\varnothing$  mm 33. Striker with blade. Fixing screws.

RIGHT-HAND. External pump cylinder mm 50

**911015/D** 1 - 1

RIGHT-HAND. External pump cylinder mm 60

**911015/D.60** 1 - 1

LEFT-HAND. External pump cylinder mm 50

**911015/S** 1 - 1

LEFT-HAND. External pump cylinder mm 60

**911015/S.60** 1 - 1

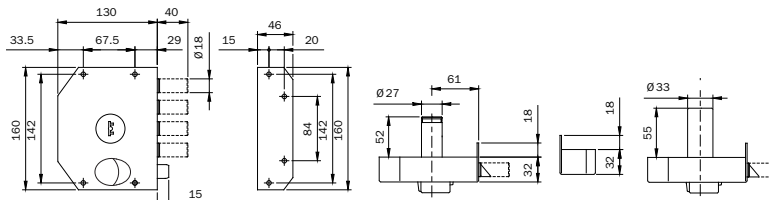
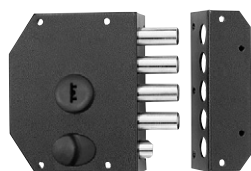

PERFECTA security rim lock. BRONZE painted. **LATERAL LOCKING** with 4 loading springs  $\varnothing$  mm 18 and latchbolt. Four mm 10 throws. **INTERNAL KEY-GUIDE**. **LATCHLOCKING BY KNOB INSIDE AND BY KEY OUTSIDE**. 3 PUMP KEYS. One ABS keyhead. Painted anti-break tube for cylinder  $\varnothing$  mm 33. Nickel plated brass escutcheon  $\varnothing$  mm 33. Striker with blade. Fixing screws.

RIGHT-HAND. External pump cylinder mm 50

**911105/D** 1 - 1

RIGHT-HAND. External pump cylinder mm 60

**911105/D.60** 1 - 1

LEFT-HAND. External pump cylinder mm 50

**911105/S** 1 - 1

LEFT-HAND. External pump cylinder mm 60

**911105/S.60** 1 - 1

Code

Multiple  
package  
Single  
package

Min. ord.

## Perfecta

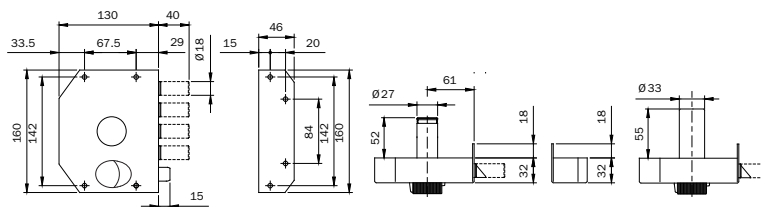
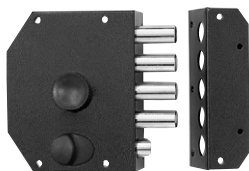

PERFECTA security rim lock. BRONZE painted. **LATERAL LOCKING** with 4 loading springs  $\varnothing$  mm 18 and latchbolt. Four mm 10 throws. **INTERNAL KNOB. LATCHLOCKING BY KNOB INSIDE AND BY KEY OUTSIDE. 3 PUMP KEYS.** One ABS keyhead.

Painted anti-break tube for external cylinder  $\varnothing$  mm 33. Brass painted escutcheon  $\varnothing$  mm 33.

Striker with blade. Fixing screws.

RIGHT-HAND. External pump cylinder mm 50

**911115/D** 1 - 1

RIGHT-HAND. External pump cylinder mm 60

**911115/D.60** 1 - 1

LEFT-HAND. External pump cylinder mm 50

**911115/S** 1 - 1

LEFT-HAND. External pump cylinder mm 60

**911115/S.60** 1 - 1

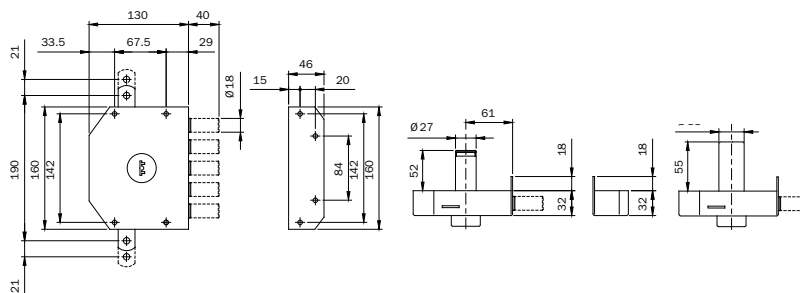
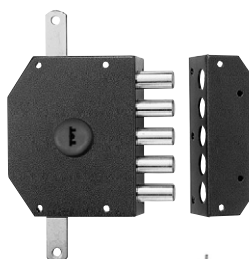

PERFECTA security rim lock. BRONZE painted. **3-POINT LOCKING.**

Lateral locking with 5 loading springs  $\varnothing$  mm 18. Four mm 10 throws. Top/bottom vertical locking with hole for rods connection, travel range mm 21. **INTERNAL KEY-GUIDE.**

Two rod-guides. Projecting part mm 35 for rods. Upper striker. Floor socket.

3 PUMP KEYS. One ABS keyhead. Painted anti-break tube for cylinder  $\varnothing$  mm 33.

Nickel plated brass escutcheon  $\varnothing$  mm 33. Striker with blade. Fixing screws.

RIGHT-HAND. External pump cylinder mm 50

**913005/D** 1 - 1

RIGHT-HAND. External pump cylinder mm 60

**913005/D.60** 1 - 1

LEFT-HAND. External pump cylinder mm 50

**913005/S** 1 - 1

LEFT-HAND. External pump cylinder mm 60

**913005/S.60** 1 - 1



Code  
Multiple  
package  
Single  
package  
Min. ord.

**Perfecta**

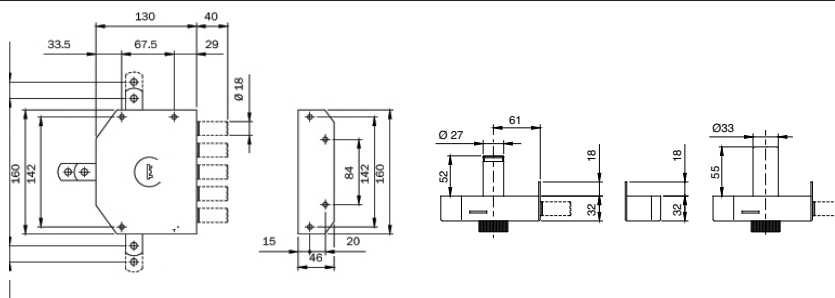
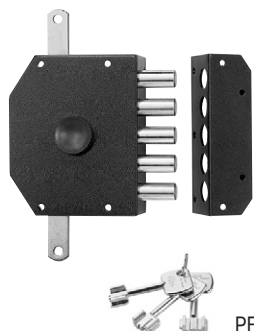

PERFECTA security rim lock. BRONZE painted. **3-POINT LOCKING.**

Lateral locking with 5 loading springs  $\varnothing$  mm 18. Four mm 10 throws. Top/bottom vertical locking with hole for rods connection, travel range mm 21. **INTERNAL KNOB.** Two rod guides.

Projecting part mm 35 for rods. Upper striker. Floor socket. 3 PUMP KEYS.

One ABS keyhead. Painted anti-break tube for external cylinder  $\varnothing$  mm 33.

Nickel plated brass escutcheon  $\varnothing$  mm 33. Striker with blade. Fixing screws

RIGHT-HAND. External pump cylinder mm 50

**913015/D** 1 - 1

RIGHT-HAND. External pump cylinder mm 60

**913015/D.60** 1 - 1

LEFT-HAND. External pump cylinder mm 50

**913015/S** 1 - 1

LEFT-HAND. External pump cylinder mm 60

**913015/S.60** 1 - 1

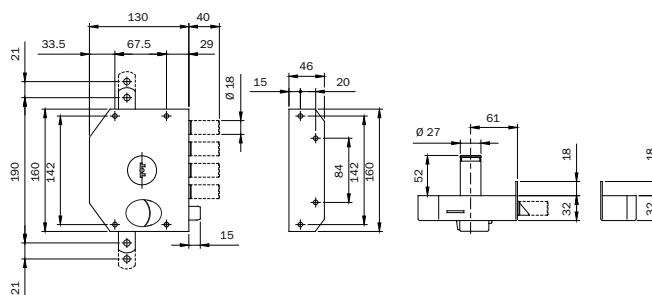
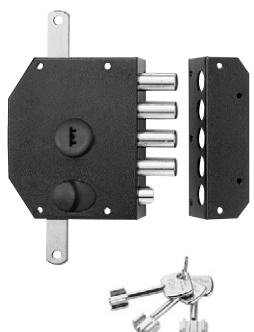

PERFECTA security rim lock. BRONZE painted. **3-POINT LOCKING.**

Lateral locking with 4 loading springs  $\varnothing$  mm 18. Four mm 10 throws. Top/bottom vertical locking with hole for rods connection, travel range mm 21. **INTERNAL KEY-GUIDE.**

**LATCHLOCKING BY KNOB INSIDE AND BY KEY OUTSIDE.** Two rod-guides. Projecting part mm 35 for rods.

Upper striker. Floor socket. 3 PUMP KEYS.

One ABS keyhead. Painted anti-break tube for cylinder  $\varnothing$  mm 33.

Nickel plated brass escutcheon  $\varnothing$  mm 33. Striker with blade. Fixing screws.

RIGHT-HAND. External pump cylinder mm 50

**913105/D** 1 - 1

RIGHT-HAND. External pump cylinder mm 60

**913105/D.60** 1 - 1

LEFT-HAND. External pump cylinder mm 50

**913105/S** 1 - 1

LEFT-HAND. External pump cylinder mm 60

**913105/S.60** 1 - 1

Code  
Multiple  
package  
Single  
package  
Min. ord.

**Perfecta**

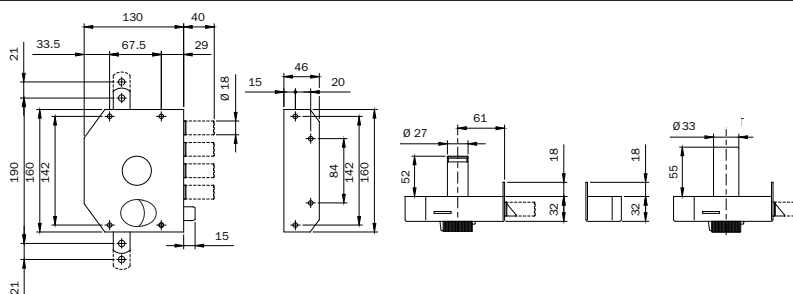
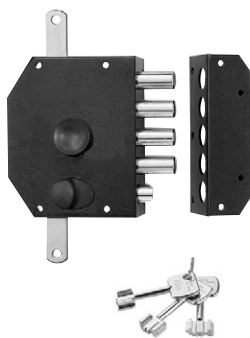

PERFECTA security rim lock. BRONZE painted. **3-POINT LOCKING.**

Lateral locking with 4 loading springs  $\varnothing$  mm 18 and latchbolt. Four mm 10 throws. Top/bottom vertical locking with hole for rods connection, travel range mm 21. **INTERNAL KNOB. LATCHLOCKING BY**

**KNOB FROM INSIDE AND BY KEY FROM OUTSIDE.** Two rod-guides. Projecting part mm 35 for rods.

Upper striker. Floor socket. 3 PUMP KEYS.

One ABS keyhead. Painted anti-break tube for external cylinder  $\varnothing$  mm 33.

Brass painted escutcheon  $\varnothing$  mm 33. Striker with blade. Fixing screws.

RIGHT-HAND. External pump cylinder mm 50

**913115/D** 1 - 1

RIGHT-HAND. External pump cylinder mm 60

**913115/D.60** 1 - 1

LEFT-HAND. External pump cylinder mm 50

**913115/S** 1 - 1

LEFT-HAND. External pump cylinder mm 60

**913115/S.60** 1 - 1

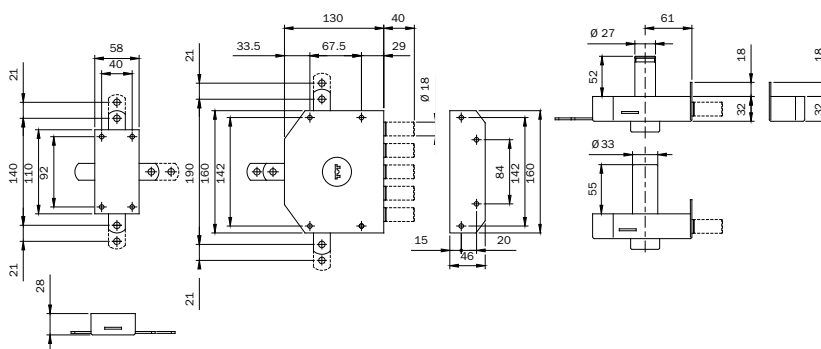
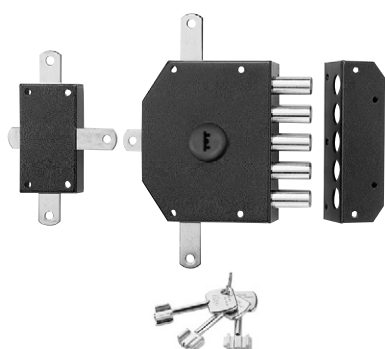

PERFECTA security rim lock. BRONZE painted. **5-POINT LOCKING.**

Lateral locking with 5 loading springs  $\varnothing$  mm 18. Four mm 10 throws. Vertical locking with back deviator and top/bottom with hole for rods connection, travel range mm 21.

**INTERNAL KEY-GUIDE.** Four rod-guides. Projecting part mm 35 for rods.

Upper striker. Two floor sockets. 3 PUMP KEYS.

One ABS keyhead. Painted anti-break tube for cylinder  $\varnothing$  mm 33.

Nickel plated brass escutcheon  $\varnothing$  mm 33. Striker with blade. Fixing screws.

RIGHT-HAND. External pump cylinder mm 50

**915005/D** 1 - 1

LEFT-HAND. External pump cylinder mm 50

**915005/S** 1 - 1

Code  
Multiple  
package  
Single  
package  
Min. ord.

**Perfecta**

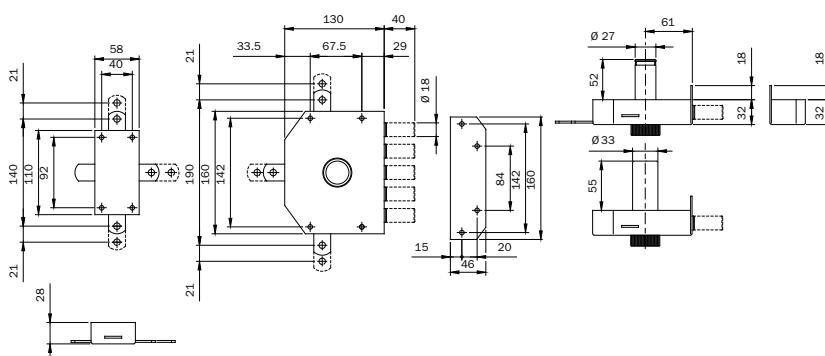
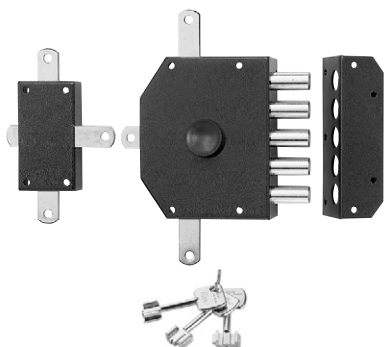

PERFECTA security rim lock. BRONZE painted. **5-POINT LOCKING.**

Lateral locking with 5 loading springs  $\varnothing$  mm 18. Four mm 10 throws. Vertical locking with back deviator and top/bottom with hole for rods connection, travel range mm 21. **INTERNAL KNOB.**

Four rod-guides. Projecting part mm 35 for rods.

Two upper strikers. Two floor sockets. 3 PUMP KEYS.

One ABS keyhead. Painted anti-break tube for cylinder  $\varnothing$  mm 33.

Nickel plated brass escutcheon  $\varnothing$  mm 33. Striker with blade. Fixing screws.

RIGHT-HAND. External pump cylinder mm 50

**915015/D** 1 - 1

LEFT-HAND. External pump cylinder mm 50

**915015/S** 1 - 1

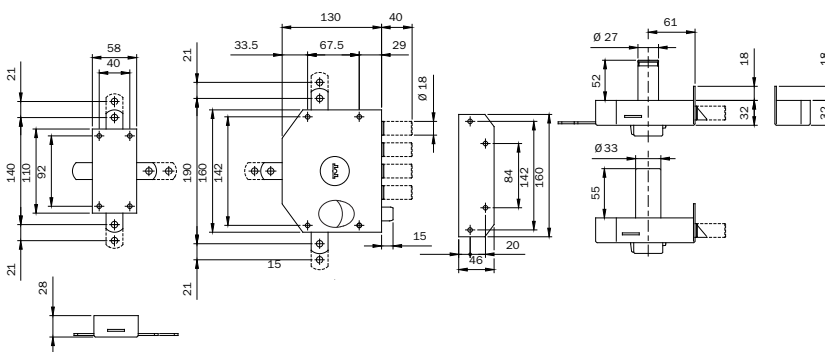
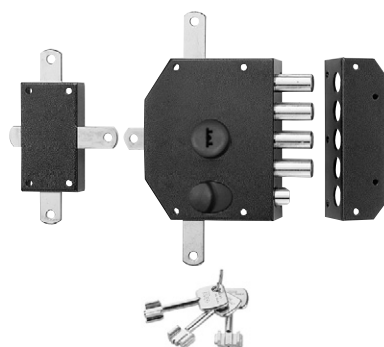

PERFECTA security rim lock. BRONZE painted. **5-POINT LOCKING.**

Lateral locking with 4 loading springs  $\varnothing$  mm 18 and latchbolt. Four mm 10 throws. Vertical locking with back deviator and top/bottom with hole for rods connection, travel range mm 21.

**INTERNAL KEY-GUIDE. LATCHLOCKING BY KNOB FROM INSIDE AND BY KEY FROM OUTSIDE.**

Four rod-guides. Projecting part mm 35 for rods. Two upper strikers.

Two floor sockets. 3 PUMP KEYS. One ABS keyhead. Painted anti-break tube for cylinder  $\varnothing$  mm 33.

Nickel plated brass escutcheon  $\varnothing$  mm 33. Striker with blade. Fixing screws.

RIGHT-HAND. External pump cylinder mm 50

**915105/D** 1 - 1

LEFT-HAND. External pump cylinder mm 50

**915105/S** 1 - 1

Code  
Multiple  
package  
Single  
package  
Min. ord.

**Perfecta**

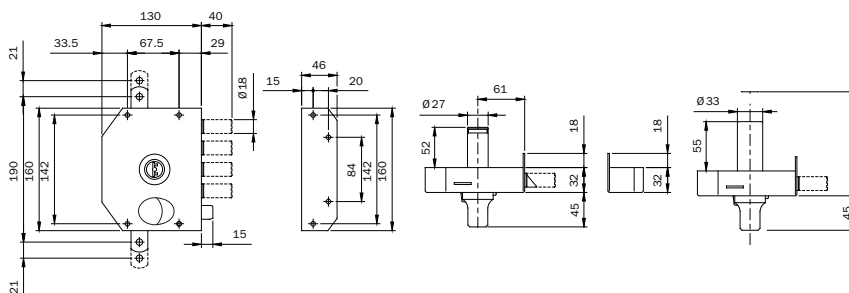
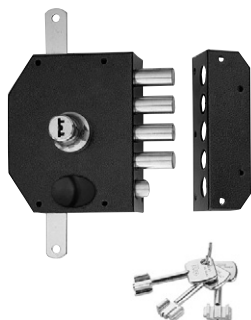

PERFECTA security rim lock. BRONZE painted. **3-POINT LOCKING.**

Lateral locking with 4 loading springs  $\varnothing$  mm 18 and latchbolt. Four mm 10 throws. Top/bottom vertical locking with hole for rods connection, travel range mm 21. Nickel-plated internal pump cylinder.

**LATCHLOCKING BY KNOB FROM INSIDE AND BY KEY FROM OUTSIDE.** Two rod-guides. Projecting part mm 35 for rods.

Upper striker. Floor socket. 3 PUMP KEYS.

One ABS keyhead. Painted anti-break tube for cylinder  $\varnothing$  mm 33.

Nickel plated brass escutcheon  $\varnothing$  mm 33. Striker with blade. Fixing screws.

RIGHT-HAND. External pump cylinder mm 50

**913125/D** 1 - 1

RIGHT-HAND. External pump cylinder mm 60

**913125/D.60** 1 - 1

LEFT-HAND. External pump cylinder mm 50

**913125/S** 1 - 1

LEFT-HAND. External pump cylinder mm 60

**913125/S.60** 1 - 1

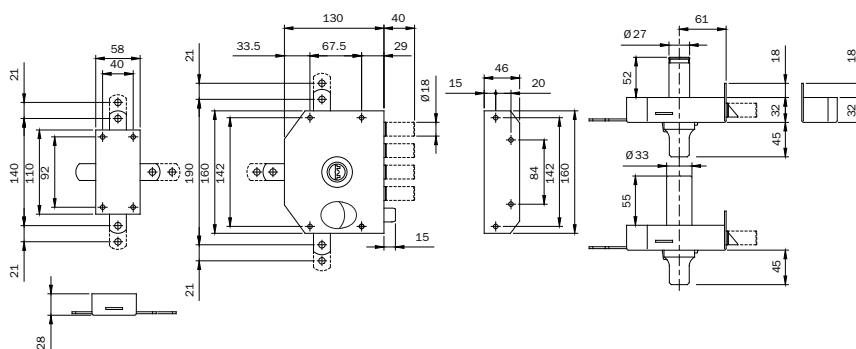
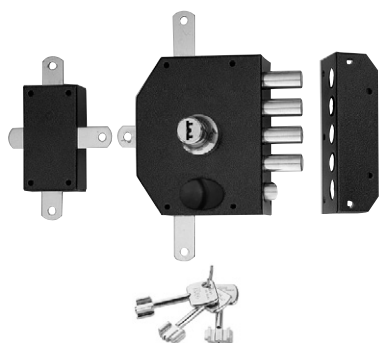

PERFECTA security rim lock. BRONZE painted. **5-POINT LOCKING.**

Lateral locking with 4 loading springs  $\varnothing$  mm 18 and latchbolt. Four mm 10 throws. Vertical locking with back deviator and top/bottom with hole for rods connection, travel range mm 21.

**NICKEL-PLATED INTERNAL PUMP CYLINDER. LATCHLOCKING BY KNOB FROM INSIDE AND BY KEY FROM OUTSIDE.**

Four rod-guides. Projecting part mm 35 for rods. Two upper strikers.

Two floor sockets. 3 PUMP KEYS. One ABS keyhead. Painted anti-break tube for cylinder  $\varnothing$  mm 33.

Nickel plated brass escutcheon  $\varnothing$  mm 33. Striker with blade. Fixing screws.

RIGHT-HAND. External pump cylinder mm 50

**915125/D** 1 - 1

LEFT-HAND. External pump cylinder mm 50

**915125/S** 1 - 1

Code

Multiple  
package  
Single  
package

Min. ord.

**Vis**

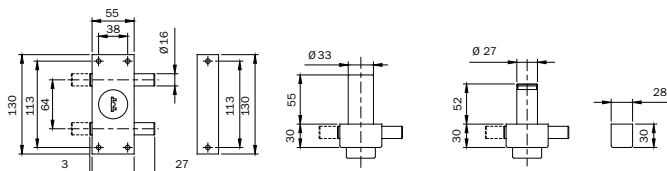

VIS reversible security rim lock. **LATERAL LOCKING** with 2 loading springs  $\varnothing$  mm 16.

One mm 27 throw. **INTERNAL KEY-GUIDE**. 3 PUMP KEYS.

One ABS keyhead. Painted anti-break tube for cylinder  $\varnothing$  mm 33.

Brass painted escutcheon  $\varnothing$  mm 33. Striker without blade. Fixing screws.

BRONZE PAINTED. External pump cylinder mm 50

**910215**

1 - 1

BRONZE PAINTED. External pump cylinder mm 60

**910215...60**

1 - 1

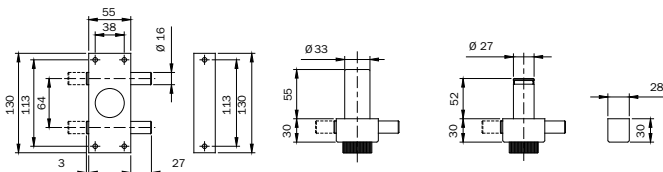

VIS reversible security rim lock. **LATERAL LOCKING** with 2 loading springs  $\varnothing$  mm 16.

One mm 27 throw. **INTERNAL KNOB**. 3 PUMP KEYS. One ABS keyhead.

Painted anti-break tube for cylinder  $\varnothing$  mm 33. Nickel plated brass escutcheon  $\varnothing$  mm 33.

Striker without blade. Fixing screws.

BRONZE PAINTED. External pump cylinder mm 50

**910315**

1 - 1

BRONZE PAINTED. External pump cylinder mm 60

**910315...60**

1 - 1

Code

Multiple  
package  
Single  
package

Min. ord.

**Vis**

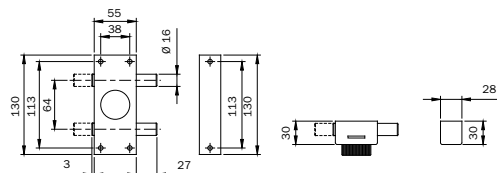

VIS reversible security rim lock. BRONZE painted. **LATERAL LOCKING** with 2 loading springs  $\varnothing$  mm 16. One mm 27 throw. **INTERNAL KNOB. WITHOUT EXTERNAL CYLINDER, WITHOUT KEYS.**

Striker without blade. Fixing screws.

**9103150**

1 - 1

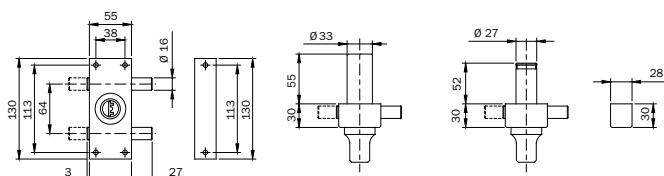

VIS reversible security rim lock. **LATERAL LOCKING** with 2 loading springs  $\varnothing$  mm 16.

One mm 27 throw. **NICKEL-PLATED INTERNAL PUMP CYLINDER. 3 PUMP KEYS.**

One ABS keyhead. Painted anti-break tube for cylinder  $\varnothing$  mm 33.

Nickel plated brass escutcheon  $\varnothing$  mm 33. Striker without blade. Fixing screws.

BRONZE PAINTED. External pump cylinder mm 50

**910415**

1 - 1

BRONZE PAINTED. External pump cylinder mm 60

**910415...60**

1 - 1

Code

Multiple  
package  
Single  
package

Min. ord.

**Vis**

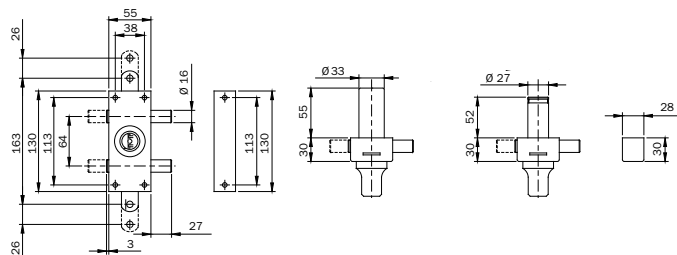
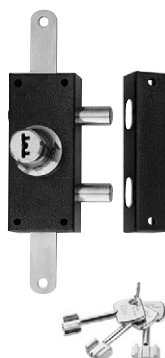

VIS reversible security rim lock. **3-POINT LOCKING**. Lateral locking with 2 loading springs  $\varnothing$  mm 16.  
One mm 27 throw. Top/bottom vertical locking with hole for rods connection, travel range mm 26. **NICKEL-PLATED INTERNAL PUMP CYLINDER**. Two rod-guides. Projecting part mm 35 for rods.  
Upper striker. Floor socket. 3 PUMP KEYS.  
One ABS keyhead. Painted anti-break tube for cylinder  $\varnothing$  mm 33.  
Nickel plated brass escutcheon  $\varnothing$  mm 33. Striker without blade. Fixing screws.  
BRONZE PAINTED. External pump cylinder mm 50 **910435** 1 - 1  
BRONZE PAINTED. External pump cylinder mm 60 **910435...60** 1 - 1

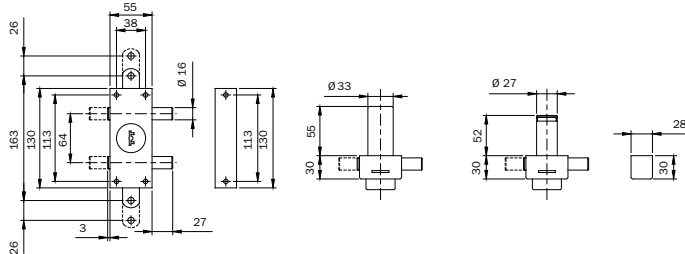

VIS reversible security rim lock. **3-POINT LOCKING**. Lateral locking with 2 loading springs  $\varnothing$  mm 16.  
One mm 27 throw. Top/bottom vertical locking with hole for rods connection, travel range mm 26. **INTERNAL KEY-GUIDE**. Two rod-guides. Projecting part mm 35 for rods.  
Upper striker. Floor socket. 3 PUMP KEYS.  
One ABS keyhead. Painted anti-break tube for cylinder  $\varnothing$  mm 33.  
Nickel plated brass escutcheon  $\varnothing$  mm 33. Striker without blade. Fixing screws.  
BRONZE PAINTED. External pump cylinder mm 50 **910235** 1 - 1  
BRONZE PAINTED. External pump cylinder mm 60 **910235...60** 1 - 1  
BLACK PAINTED. External pump cylinder mm 50 **910235..N** 1 - 1  
BLACK PAINTED. External pump cylinder mm 60 **910235..N60** 1 - 1

Code

Multiple  
package  
Single  
package

Min. ord.

**Vis**

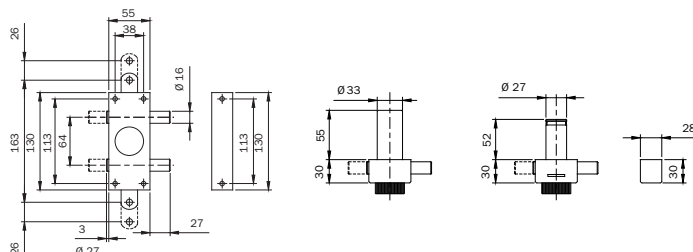

VIS reversible security rim lock. **3-POINT LOCKING**. Lateral locking with 2 loading springs  $\varnothing$  mm 16. One mm 27 throw. Top/bottom vertical locking with hole for rods connection, travel range mm 26.

**INTERNAL KNOB**. Projecting part mm 35 for rods. Upper striker. Floor socket.  
3 PUMP KEYS. One ABS keyhead. Painted anti-break tube for cylinder  $\varnothing$  mm 33.  
Nickel plated brass escutcheon  $\varnothing$  mm 33. Striker without blade. Fixing screws.

|  |                    |   |   |   |
|--|--------------------|---|---|---|
| BRONZE PAINTED. External pump cylinder mm 50 | <b>910335</b>      | 1 | - | 1 |
| BRONZE PAINTED. External pump cylinder mm 60 | <b>910335...60</b> | 1 | - | 1 |
| BLACK PAINTED. External pump cylinder mm 50  | <b>910335..N</b>   | 1 | - | 1 |
| BLACK PAINTED. External pump cylinder mm 60  | <b>910335..N60</b> | 1 | - | 1 |

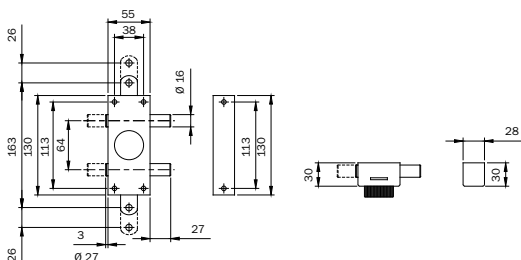

VIS reversible security rim lock. BRONZE painted. **3-POINT LOCKING**. Lateral locking with 2 loading springs  $\varnothing$  mm 16. One mm 27 throw. Top/bottom vertical locking with hole for rods connection, travel range mm 26.

**INTERNAL KNOB. WITHOUT EXTERNAL CYLINDER, WITHOUT KEYS. TWO ROD GUIDES.**

Projecting part mm 35 for rods. Upper striker. Floor socket. Striker without blade.

|               |                |   |   |   |
|---------------|----------------|---|---|---|
| Fixing screws | <b>9103350</b> | 1 | - | 1 |
|---------------|----------------|---|---|---|

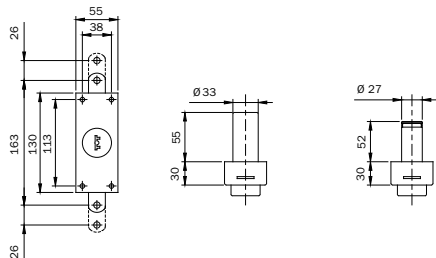

Security rim lock. **2-POINT LOCKING**. Top/bottom vertical locking with hole for rods connection, travel range mm 26. **INTERNAL KEY-GUIDE**. Two rod-guides. Projecting part mm 35 for rods.

Upper striker. Floor socket. **3 PUMP KEYS**. One ABS keyhead.

Painted anti-break tube for cylinder  $\varnothing$  mm 33.

Nickel plated brass escutcheon  $\varnothing$  mm 33. Fixing screws.

|  |                    |   |   |   |
|--|--------------------|---|---|---|
| BRONZE PAINTED. External pump cylinder mm 50 | <b>910205</b>      | 1 | - | 1 |
| BRONZE PAINTED. External pump cylinder mm 60 | <b>910205...60</b> | 1 | - | 1 |
| BLACK PAINTED. External pump cylinder mm 50  | <b>910205..N</b>   | 1 | - | 1 |
| BLACK PAINTED. External pump cylinder mm 60  | <b>910205..N60</b> | 1 | - | 1 |



Code

Multiple package  
Single package

Min. ord.

**Vis**

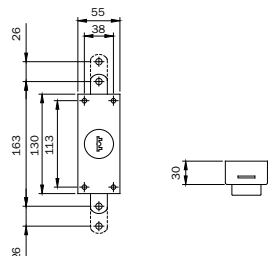

Security rim lock. **2-POINT VERTICAL LOCKING**. BRONZE painted.  
**INTERNAL KEY-GUIDE. WITHOUT EXTERNAL CYLINDER, WITHOUT KEYS.** Top/bottom locking with hole for rods connection, travel range mm 26. Two rod guides.  
 Projecting part mm 35 for rods.  
 Upper striker. Floor socket. Fixing screws.

**9102050** 1 - 1

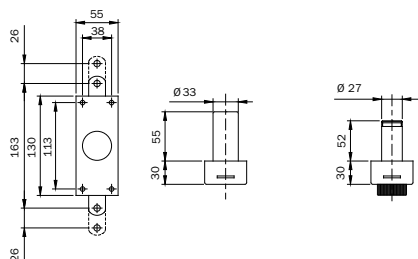

Security rim lock. **2-POINT VERTICAL LOCKING. INTERNAL KNOB.** Top/bottom locking with hole for rods connection, travel range mm 26. Two rod guides. Projecting part mm 35 for rods.  
 Upper striker. Floor socket. 3 PUMP KEYS. One ABS keyhead.  
 Painted anti-break tube for cylinder Ø mm 33.  
 Nickel plated brass escutcheon Ø mm 33. Fixing screws.

|  |                    |   |   |   |
|--|--------------------|---|---|---|
| BRONZE PAINTED. External pump cylinder mm 50 | <b>910305</b>      | 1 | - | 1 |
| BRONZE PAINTED. External pump cylinder mm 60 | <b>910305...60</b> | 1 | - | 1 |
| BLACK PAINTED. External pump cylinder mm 50  | <b>910305..N</b>   | 1 | - | 1 |
| BLACK PAINTED. External pump cylinder mm 60  | <b>910305..N60</b> | 1 | - | 1 |

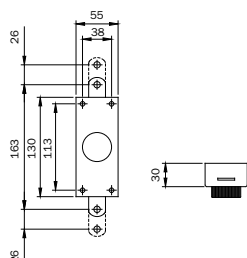

Security rim lock. **2-POINT VERTICAL LOCKING**. BRONZE painted.  
**INTERNAL KNOB. WITHOUT EXTERNAL CYLINDER, WITHOUT KEYS.** Top/bottom locking with hole for rods connection, travel range mm 26. Two rod guides.  
 Projecting part mm 35 for rods. Upper striker.  
 Floor socket. Fixing screws

**9103050** 1 - 1

Code

Multiple  
package  
Single  
package

Min. ord.

**Vis**

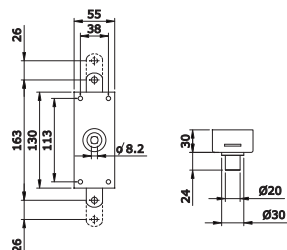

Deviator for second leaf. **2-POINT VERTICAL LOCKING. PREARRANGED FOR INTERNAL SELF-LOCKING KNOB.**

**WITHOUT EXTERNAL CYLINDER, WITHOUT KEYS.** Top/bottom locking with hole for rods connection, travel range mm 21. Two rod guides. Projecting part mm 35 for rods. Upper striker.

Floor socket. Fixing screws.

BRONZE PAINTED

**9103250**

1 - 1

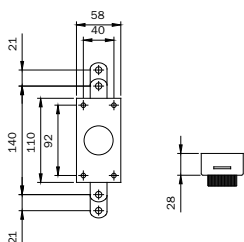

Security rim lock. **2-POINT VERTICAL LOCKING. INTERNAL SELF-LOCKING KNOB.**

**WITHOUT EXTERNAL CYLINDER, WITHOUT KEYS.** Top/bottom locking with hole for rods connection, travel range mm 21. Two rod guides. Projecting part mm 35 for rods. Upper striker.

Floor socket. Fixing screws.

BRONZE PAINTED

**910105**

1 - 1

BLACK PAINTED

**910105..N**

1 - 1

Code

Multiple  
package  
Single  
package

Min. ord.

## Accessories

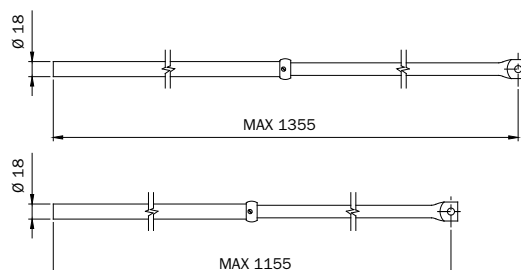

Pair of telescopic rods for 3-point security locks PERFECTA series 910-913. Tip Ø 18.

Rings with screw supplied.

BRONZE PAINTED

**990063**

1 - 1

BLACK PAINTED

**990063..N**

1 - 1

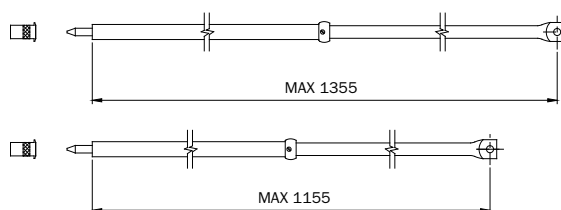

Pair of telescopic rods for 3-point security locks PERFECTA series 910-913. Tip Ø 9.

Rings with screw supplied. Two anti-dust sockets.

BRONZE PAINTED

**990063.RB**

1 - 1

BLACK PAINTED

**990063.RBN**

1 - 1

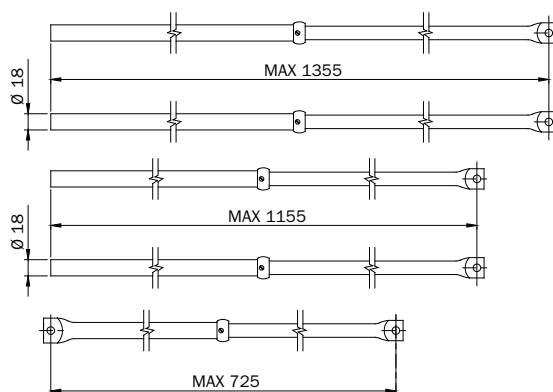

Pair of telescopic rods for 5-point security locks PERFECTA series 915.

Tip Ø mm 18. BRONZE painted. Ring with screw supplied.

**990067**

1 - 1

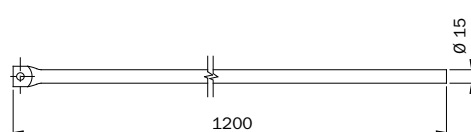

Internal extension Ø mm 15x1200 for rods series 990063-990067 for doors max height mm 3200. BRONZE PAINTED.

**990122**

1 - 1

Code  
Multiple  
package  
Single  
package  
Min. ord.

## Accessories



Brass locking ring for telescopic rods series 990063-990067. Fixing screw.

**990123**

10 - 10

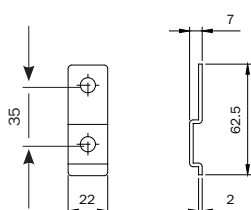

Projecting part mm 62, holes center distance mm 35 for rods, for PERFECTA security locks series 910-911-913-915. BRONZE painted. Screw and screw nut.

**990049**

10 - 10

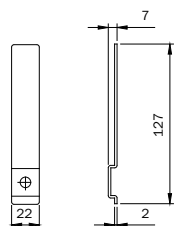

Projecting part mm 127, holes center distance up to mm 100 for rods, for PERFECTA security locks series 910-911-913-915. BRONZE painted. Screw and screw nut.

**990053**

10 - 10

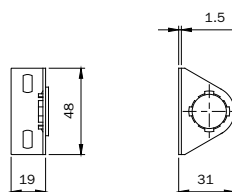

Rod guide Ø mm 18 series 990063-990067. BRONZE PAINTED.

**990099**

10 - 10

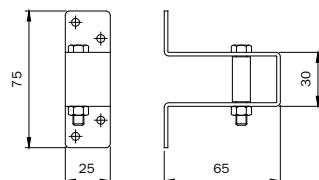

Standard upper U-striker for rods Ø mm 18 series 990063-990067. Pin with adjustable rod guide. BRONZE PAINTED.

**990103**

5 - 5

Code

Multiple  
package  
Single  
package

Min. ord.

## Accessories

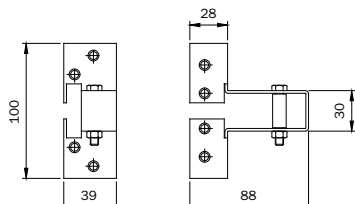

Angle upper U-striker with blades for rods  $\varnothing$  mm 18 series 990063-990067.

Pin with adjustable rod guide. BRONZE PAINTED.

**990108**

5 - 5

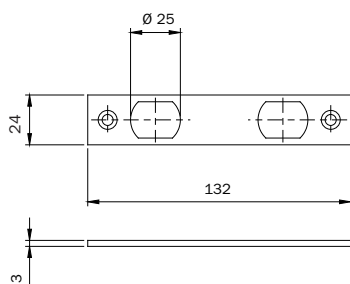

Heavy flat striker, with slots D25 for deadbolts, for VIS locks series 910.

In steel mm 132x24x3.

BRONZE PAINTED

**032085**

10 - 10

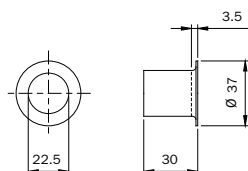

Brass floor socket for rods. Inside hole  $\varnothing$  mm 22,5.

For rods  $\varnothing$  mm 18 series 990063-990067.

**990094**

10 - 10

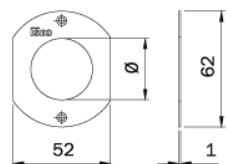

Brass flat escutcheon for pump cylinder, cylinder hole  $\varnothing$  mm 27.

**990084**

10 - 10

Brass flat escutcheon for pump cylinder, anti-break tube hole  $\varnothing$  mm 33.

**990086**

10 - 10

**Nickel-plated brass** flat escutcheon for pump cylinder, anti-break tube hole  $\varnothing$  mm 33.

**990083**

10 - 10

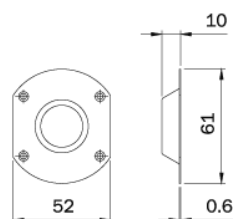

Concave brass escutcheon for pump cylinder, cylinder hole  $\varnothing$  mm 27.

**990090**

10 - 10

Convex brass escutcheon for pump cylinder, cylinder hole  $\varnothing$  mm 27.

**990090/C**

10 - 10

Code  
Multiple  
package  
Single  
package  
Min. ord.

## Accessories

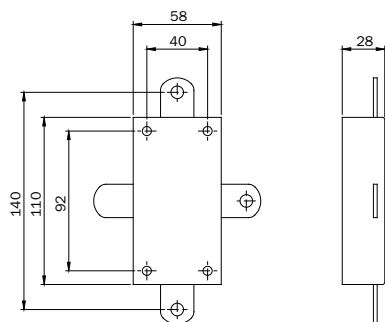

Deviator for rods for PERFECTA 5-point security lock series 915. BRONZE PAINTED. **990075** 1 - 1

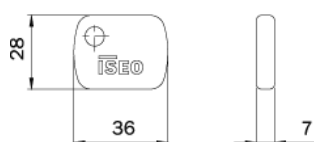

Nylon keyhead for double-bit and pump keys series 990\*\*\*. **990000** 10 - 10

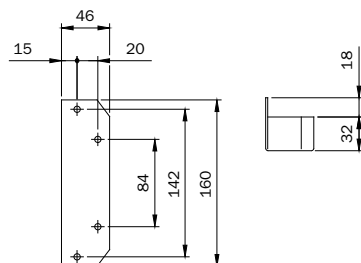

Standard striker with blade for PERFECTA security locks series 911-913-915. BRONZE PAINTED. **990033** 1 - 1

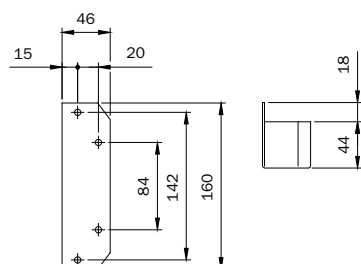

Raised striker with blade for PERFECTA security locks series 911-913-915. BRONZE PAINTED. **990037** 1 - 1

Code

Multiple  
package  
Single  
package

Min. ord.

## Accessories

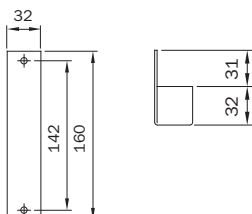

Striker reduced to mm 28x156, raised with blade, for PERFECTA security locks series 911-913-915. BRONZE PAINTED.

**990038**

1 - 1

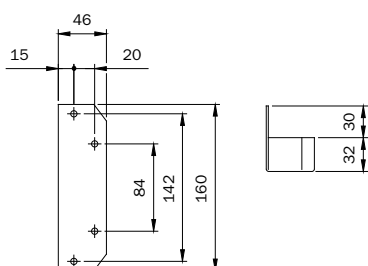

Striker with extended blade for PERFECTA security locks series 911-913-915. BRONZE PAINTED.

**990254**

1 - 1

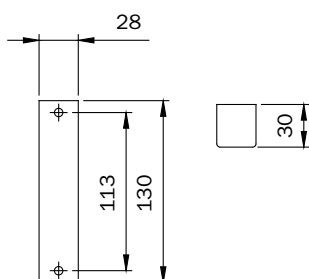

Standard striker without blade for VIS security locks series 910. BRONZE PAINTED.

**990275**

1 - 1

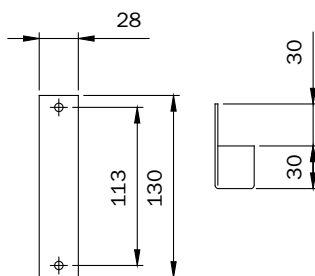

Striker with extended blade mm 30 for VIS security locks series 910. BRONZE PAINTED.

**990295**

1 - 1

Code

Multiple  
package  
Single  
package

Min. ord.

## Accessories

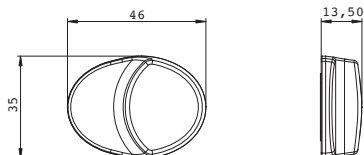

Knob for latchbolt, for PERFECTA security rim locks. BLACK.

**990130**

1 - 1

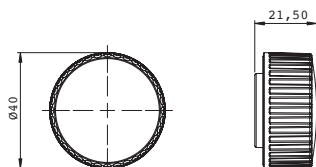

Knob for bolt-throw, for VIS security rim locks. BLACK.

**990131**

1 - 1











## Doors opening direction

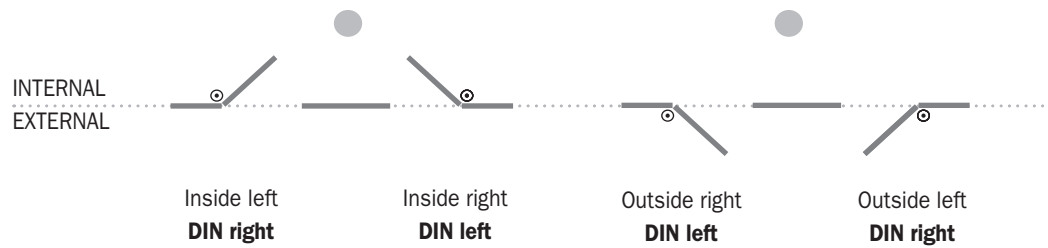

## Use Instructions

To lubricate the cylinder use only teflon Interflon Finlube TF.



When assembling, make sure drillings and filings do not enter the lock.

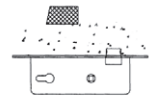

Do not paint the lock front plate, since this may cause damages to the deadbolt and the latchbolt.



Fixing screws must not cause damage to the product.

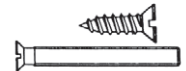

For installation, carefully follow the user's instructions or call skilled staff.

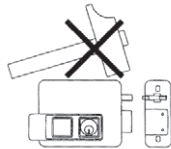

To install the lock exclusively use the transformers recommended in the instructions.

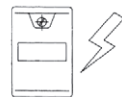



[www.iseo.com](http://www.iseo.com)

**Iseo Serrature s.p.a.**

■ Via San Girolamo 13  
25055 Pisogne (BS) - Italy  
☎ +39 0364 8821  
Fax +39 0364 882263  
[iseo@iseo.com](mailto:iseo@iseo.com)

■ Via Don Fasola, 4  
22069 Rovellasca (CO) - Italy  
☎ +39 02 96740420  
Fax +39 02 96740309  
[info.fiam@iseo.com](mailto:info.fiam@iseo.com)

**Iseo France s.a.s.**

Zone Industrielle  
1111, rue du Maréchal Juin  
CS 90367 Vaux Le Pénil  
77006 Melun Cédex - France  
☎ +33 1 64835858  
Fax +33 1 64879685  
[city.iseofrance@iseo.com](mailto:city.iseofrance@iseo.com)

**Iseo Middle East F.Z.E.**

PO. Box 61390  
Jebel Ali, Dubai  
United Arab Emirates  
☎ +9 714 2957220  
Fax +9 714 2957166  
[iseome@emirates.net.ae](mailto:iseome@emirates.net.ae)

**Olso Meccanica s.r.l.**

Via della Meccanica 23  
41018 San Cesario s.P. (MO)  
Italy  
☎ +39 059 927948  
Fax +39 059 927972  
[info.olso@iseo.com](mailto:info.olso@iseo.com)

**Feroneria Prod S.A.**

Calea 6 Vânători 51-53  
310162 Arad (AR) - România  
☎ +40 257 250 225  
Fax +40 257 257 127  
[feroneria@iseo.com](mailto:feroneria@iseo.com)

**Iseo Asia Pacific Sdn Bhd**

15-21 Jalan 22  
Taman Bukit Kuchai  
47190 Puchong, Selangor D.E  
Malaysia  
☎ +603 8075 3331  
Fax +603 8075 9333  
[info@iseo.com.my](mailto:info@iseo.com.my)

**Iseo Deutschland GmbH**

Wiesestraße 190  
07548 Gera - Germany  
☎ +49 365 73620  
Fax +49 365 7362135  
[info.iseodeutschland@iseo.com](mailto:info.iseodeutschland@iseo.com)

**Cerraduras Iseo Ibérica S.L.**

C/ Las Marineras 2  
28864 Ajalvir - Madrid - Spain  
☎ +34 91 8843200  
Fax +34 91 8843003  
[iseo@iseoiberica.es](mailto:iseo@iseoiberica.es)

**Iseo Projects and Access Control DMCC**

PO. Box 336998 JLT  
Cluster T One Lake Plaza, Dubai  
United Arab Emirates  
☎ +9 714 5136162  
Fax +9 714 5576488  
[iseoprojects@iseo.com](mailto:iseoprojects@iseo.com)

**Microhard s.r.l.**

Via Don Fasola, 4  
22069 Rovellasca (CO) - Italy  
☎ +39 02 96749084  
Fax +39 02 73965117  
[info.mh@iseo.com](mailto:info.mh@iseo.com)

**Iseo South Africa (Pty) Ltd**

Unit C2, Maitland Industrial Park  
733 Voortrekker Road, Maitland  
7405 Cape Town - South Africa  
☎ +27 21 593 0101  
Fax +27 21 593 0110  
[sales@iseo.co.za](mailto:sales@iseo.co.za)

**Iseo Beijing**

Arch. Hardware Co.Ltd.  
Room 1001 Bldg 11 Jianwai Soho  
39 East 3RD Ring Road  
Chaoyang District - Beijing  
PR. China 100021  
☎ +86 10 5869 8079  
Fax +86 10 5869 4282  
[admin.cn@iseoasia.com](mailto:admin.cn@iseoasia.com)

**Iseo Colombia s.a.s.**

Calle 122 # 19A - 55  
110111 Bogotá - Colombia  
☎ +57 1 807 7712  
Fax +57 1 807 7713  
[info.iseocolombia@iseo.com](mailto:info.iseocolombia@iseo.com)

